

Design Manual for Health Services Facilities in the Caribbean

with particular reference to
Natural Hazards and
Other Low-frequency Events

Tony Gibbs



Pan American Health Organization

Regional Office of the



World Health Organization

Humanitarian
Aid Office



With the support of the
Programme on Disaster Preparedness of the
Humanitarian Aid Office of the European Commission

This document was authored by Tony Gibbs of Consulting Engineers Partnership Ltd for the Pan American Health Organization under the Disaster Preparedness Programme of the Humanitarian Aid Office of the European Commission.

Dana Van Alphen, PAHO Regional Advisor in Disaster Preparedness in the Caribbean, provided support.

Curtis Challenor of Genesis Graphics (Barbados) assembled the document for the printers.

ISBN 976-8080-558

The Pan American Health Organization welcomes requests for permission to reproduce or translate its publications, in part or in full. Applications and inquiries should be addressed to the Caribbean Programme Coordinator, Pan American Health Organization, P.O. Box 508, Bridgetown, Barbados, WI., who will be glad to provide the latest information on any changes made to the text, plans for new editions, and reprints and translations already available.

CONTENTS

1 Introduction 5

1.1 Purpose of the Document

1.2 Issues Not Usually Addressed in Design Manuals

1.3 The Need for Special Attention to Natural Hazards and Other Low-frequency Events

1.4 In-house Resources and Outside Assistance

1.5 Objectives

2 Consultants 9

2.1 Selecting Consultants

2.2 Terms of Reference for Design Consultants

2.3 Design Team Leader

2.4 Independent Reviews

3 Standards for Design 10

3.1 General

3.2 Design Criteria for Wind

3.3 Design Criteria for Earthquake

3.4 Design Criteria for Torrential Rain

3.5 Design Criteria for Storm Surge and Tsunami

3.6 Design Guidance for Explosions

3.7 Design Guidance for Fire

4 Non-structural Components 24

4.1 General

4.2 Fixed Components to be Considered by Design Professionals

4.3 Movable Items to be Addressed by the Hospital Staff

5 Vulnerability Audits and Setting Implementation Priorities 25

5.1 Vulnerability Audits

5.2 Priorities

6 Retrofitting and Maintenance of Existing Facilities 26

6.1 Maintenance, Repairs and Replacement as a Tool for Mitigation

6.2 Other Issues

A Appendices

A-I Selecting Consultants iii

A-II Terms of Reference for Design Consultants v

A-III Check List for the Design Team Leader ix

A-IV Independent Reviews xiii

A-V Check List for Designing to Counteract Natural Hazards xvii

A-VI Base Isolation for Buildings xxv

A-VII Design of New Buildings Considering the Explosion Hazard xxxi

A-VIII Check List for Non-structural Components for Earthquakes xxxvii

A-IX Check List for Non-structural Components for Hurricanes xliii

A-X	Rational Approach to Determining Priorities for Retrofitting Healthcare Buildings	xlvii
A-XI	Maintenance as a Tool for Mitigation	lv
A-XII	Resource Centres and Background Reading	lxviii

Figures:

Figure 1	Regional Map of Wind-pressure Contours	11
Figure 2	Wind-speed Variation with Averaging Period	13
Figure 3	S3 Factor for Return Period and Probabilities	14
Figure 4a	Isoacceleration Map of the Caribbean (10% 0.2 sec)	17
Figure 4b	Isoacceleration Map of the Caribbean (10% 1.0 sec)	17
Figure 4c	Isoacceleration Map of the Eastern Caribbean (2% 0.2 sec)	18
Figure 4d	Isoacceleration Map of the Eastern Caribbean (2% 1.0 sec)	18
Figure 5	Intensity-Frequency-Duration Curves for a Selected Location	20
Figure 6	Tsunami Heights for Realistic Kick 'em Jenny Eruption	22
Figure Ap1	Large Oscillation of Structure Without Base Isolators	xxv
Figure Ap2	Different Positions for Base Isolators	xxvi
Figure Ap3	Small Oscillation of Structure without Base Isolators	xxvii
Figure Ap4	Isolators made of Banded Elastomeric Material	xxviii
Figure Ap5a	Sliding Plates	xxviii
Figure Ap5b	Mechanism with Concave Sliding Surfaces	xxix
Figure Ap6	Gantt Chart for 5-year Plan	xlvii
Flow Chart 1	Selection of Building for Evaluation	li
Flow Chart 2	Qualitative Assesment	lii
Figure Ap7	Permissible Time for Natural-hazard Damage Abatement	liii
Flow Chart 3	Analytical Evaluation	liv

- 5 the preparation of a CD-ROM consisting of a compilation of vulnerability analyses of Caribbean hospitals that have been carried out under other ECHO projects;
- 6 the participation through presentation of prepared papers in the PAHO “Leaders” Course in Jamaica in February 2003.

The additional aim of the present project and the specific aim of this document is:

- 7 to promote vulnerability reduction through appropriate procedures in the commissioning, design and execution of capital works projects in the health sector.

It is recognised that the suitability of healthcare facilities depends on several factors other than structural safety. Some of these factors are location, water storage and supply, standby power and telecommunications within the facility and externally. Obviously the functional and administrative aspects of the facility are of paramount concern. Most of these issues are already being addressed by other agencies. The focus of this document is on the physical vulnerability of the facilities to wind forces, seismic forces, torrential rain and some other low-frequency events.

This document is addressed to those who commission, manage and monitor capital works projects in the health sector. It is also addressed to those who design such projects. It is important that the owners or custodians and the designers of healthcare facilities have a common understanding of the objectives and performance expectations of such facilities in the face of natural hazards. This document will go some way in filling that gap which exists at present.

1.2 Issues not Usually Addressed in Design Manuals

It is often not sufficient to specify appropriate standards for projects. There is also the need to ensure that the standards are being followed and are being interpreted correctly. The design consultants are at the centre of this issue.

As an aid to addressing these problems there are presented in this document guidance on the selection of consultants, terms of reference for design consultants, a checklist for the design team leader and thoughts on the independent reviews of designs.

The terms of reference are deliberately more detailed than usual. This would facilitate a more orderly approach to the execution of the consultants’ functions and also facilitate the monitoring of these functions by the clients’ representatives. Experience shows that such an orderly approach reduces the incidence of oversights, reduces abortive work by the consultants and leads to a more efficient project overall.

This Manual also provides guidance on vulnerability audits and the setting of implementation priorities for a portfolio of healthcare facilities. Maintenance of facilities is a major challenge in the Caribbean so that this issue is addressed in detail in an appendix.

1 INTRODUCTION

1.1 The Purpose of the Document

Throughout the world, including the Caribbean, natural hazards cause as much damage to healthcare facilities as they do to buildings of less importance. This is both regrettable and avoidable. Healthcare facilities deserve special attention because of their roles during the active periods of storms and also as post-disaster assets.

It goes without saying that the damage and destruction of hospitals would put the affected population at risk during severe storms and after all severe natural-hazard events. (See section 1.3 in this Manual.)

It is often said that safe buildings may not be affordable, especially in relatively-poor, developing countries. This is a fallacy. Particularly with respect to hurricane resistance, safe buildings are not only technically feasible but also achievable at very modest cost. This thesis has been tested and confirmed on several occasions over the years.

The Pan American Health Organization (PAHO) has been in the forefront of promoting safer buildings (including, but not limited to healthcare facilities) in the Caribbean during the past two decades. In the present programme PAHO is assisted by funding from the Disaster Preparedness Programme of the Humanitarian Aid Office of the European Commission (DIPECHO). The present programme (DIPECHO-III) included:

- 1 a comparison of building codes and practices which are in use in the Caribbean (Dominican Republic, French Antilles, CUBiC¹, Bahamas, OECS²), focussing on design and construction of healthcare facilities³;
- 2 the formation of an Expert Committee for advising ministries of health that are planning new health infrastructure, especially those funded by international agencies;
- 3 the holding of a regional seminar on natural hazards and on mechanisms for the enforcement of hospital standards of design and construction⁴;
- 4 the preparation of a CD-ROM on the basic principles of hospital building design for hurricanes to complement the existing PAHO CD-ROM on earthquakes;

¹Caribbean Uniform Building Code published by the Caribbean Community Secretariat principally for the Commonwealth Caribbean

²Organisation of Eastern Caribbean States

³Report on the Comparison of Building "Codes" and Practices which are in use in the Caribbean (principally Bahamas, CUBiC, Dominican Republic, French Antilles, OECS) focussing on design and construction of healthcare facilities – May 2003

⁴<http://disaster-info.net/carib/WindsofChange/>

1.3 The Need for Special Attention to Natural Hazards and Other Low-frequency Events

The problem of natural hazard damage mitigation should be one of conscious concern to health officials in the Caribbean. Consider the following:

- probabilities of occurrences of severe hurricanes, earthquakes and torrential rains are real;
- damage potential is increasing;
- there are few legally-enforceable and effectively-enforced engineering and architectural design standards in the Caribbean;
- most standards and codes in common use do not adequately address the important question of non-structural elements;
- with appropriate design and construction techniques it is feasible to protect facilities so that they remain in operation after a natural-hazard event;
- protection costs are affordable;
- codes provide minimum standards which may not be sufficient for healthcare facilities.

1.4 In-house Resources and Outside Assistance

Ministries of health do not commonly use their in-house engineers and architects to design/supply/build new civil works. Indeed, in general, ministries of health do not usually employ in-house engineers and architects. Almost all new works to do with site development (roads, drainage, water supply, sewerage); buildings and equipment foundations are contracted out to independent consultants. The Manual, therefore, focuses on helping ministries of health in the contracting of outside consultants and in the procurement of capital works. There is, however, the question of existing works, equipment and services and how to reduce their vulnerability to the effects of natural hazards.

One of the important purposes of the Manual would be to guide the ministry of health representative in the initial briefing of the consultants:

*“If you do not take trouble at the beginning,
you will most certainly be given it before the end.”*
Sir Hugh Casson

Ministries of health require certain standards of reliability and performance, and consultants and suppliers are usually capable of providing them. What is often lacking, however, is a clear articulation of those standards, performance criteria and expectations by the ministry of health’s representative to consultants and suppliers. This Manual would facilitate communication and make it more reliable and consistent.

It is accepted that the construction industry has available to it a number of engineers and architects skilled in the general fields of design and construction. However the needs of the ministries of health encompass all those general requirements and, in addition, include the special factors peculiar to the provision of health care without disruption during the worst of times. These special factors need to be consciously spelt

out in such a manner that there would be little room for misunderstanding on the part of consultants and suppliers.

It is rarely sufficient for a ministry of health simply to employ good consultants and let them get on with the work. It is rarely sufficient for a ministry of health simply to order supplies from reputable manufacturers and let them get on with delivery and installation. The briefing of consultants and the procurement of supplies requires the making of informed choices based on an appreciation of the implications of varying criteria for costs and performance.

Ministries of health recognise the positive and sustained contribution they have to make to their communities. This demands that their facilities perform in a reliable and predictable manner when impacted by hurricanes, floods and earthquakes. However, there is often a gap of understanding to be bridged between the ministries of health and their consultants and suppliers with respect to the performance expectations of physical facilities. It is in the interest of all parties that this should not happen, since health care is a post-disaster asset of the first order and bad surprises must be minimised. This Manual should go some way towards bridging that gap.

1.5 Objectives

The objectives for which this Manual will make a contribution include (*inter alia*):

- dissemination of the experience gained from previous natural disasters and from studying the vulnerability of healthcare facilities so as to reduce the adverse effects of future events;
- facilitating the inclusion of specific measures for the mitigation of disasters and related aspects of preparedness in the overall planning of healthcare facilities;
- helping senior ministry of health representatives in understanding the nature and extent of the exposures to their properties posed by natural hazards;
- assisting in the reduction of the risks (within the limits imposed by economics) through informed decision making and planning;
- providing specific, formal, structured guidance on the briefing of consultants; the development of design criteria; the monitoring of consultants; the formulation of performance specifications for procurement of products not involving the use of consultants;
- outlining the specific issues of vulnerability analysis of existing facilities and their retrofitting when such is indicated;
- introducing the analysis of the vulnerability of existing works and equipment;
- monitoring of signs of deterioration;
- determining the adequacy of design standards;
- providing guidance on when to call in a consultant to analyse vulnerability;
- reducing the vulnerability of existing works and equipment;
- promoting better maintenance practices and monitoring;
- setting of priorities for retrofitting;
- describing performance specifications for retrofitting.

The ultimate goal is to reduce the element of surprise by providing buildings, structures and civil works of predictable performance at affordable costs.

2 CONSULTANTS

2.1 Selecting Consultants

This is a critical function in the process of producing safe, functional healthcare facilities. Detailed guidance on this process is provided in Appendix A-I – “Selecting Consultants”.

The Appendix deals with the critical characteristics, selection criteria and selection procedures.

2.2 Terms of Reference for Design Consultants

It is considered that more reliable and predictable performance of the consulting team and better results for the project overall will be facilitated by detailed teams of reference being prepared by the client and agreed with the consultants. To assist in this process, suggested terms of reference are provided in Appendix A-II – “Terms of Reference for Design Consultants” of this document.

The Appendix deals with briefing; specific discussion on natural hazards and agreement of performance expectations; steps in the monitoring of consultants and approval stages; document search and interviews; field surveys and laboratory tests; preliminary appraisals, conceptual design and project definition; design stage II; the tender process and the construction stage.

2.3 Design Team Leader

It is usual that an architect leads the design team for hospitals and clinics. As team leader the architect integrates the work of the various engineering disciplines and other specialists. With respect to the design of facilities for natural hazards (earthquakes, hurricanes and torrential rain) the traditional education, training and experience of the architectural profession do not commonly prepare the practitioners well. To assist the architect, as design team leader, Appendix A-III – “Check List for the Design Team Leader” is included in this Manual.

2.4 Independent Reviews

Several Caribbean countries have formal procedures for the approval of designs of buildings prior to construction. In some of these cases the standards are not defined but are left to the individual working in the checking authorities. In other countries there are neither defined standards nor legally-enforceable codes. In the best of circumstances there would be legally-mandated codes (laws and regulations), defined technical standards and effective enforcement of the standards. Such a situation comes closest to reality in the Caribbean only in the French Antilles. There exists in the French Antilles a process which has a good chance of providing effective enforcement of the standards. More information on such a system is provided in Appendix A-IV – “Independent Reviews”.

3 STANDARDS FOR DESIGN

3.1 General

Codes of practice and standards should be used for new construction to achieve more consistent and predictable performance and to improve levels of safety.

Very commonly consultants use the minimum standards of codes, usually because of commercial pressures. Also, most codes are for general construction and not specific to the needs of critical infrastructure projects such as healthcare facilities.

There is also the problem of building to unnecessarily high and expensive standards. Clients (in consultation with their consultants) should select, on informed and rational bases, appropriate design criteria for facilities of differing importance. Suggestions for healthcare facilities are made in the following sections 3.2 to 3.5 to assist in this process, but not to preempt such consultation and selection.

Sections 3.6 and 3.7 provide guidance on certain manmade, low-frequency events.

Clients should recognise the need to review, on an ongoing basis, the conditions of their facilities and their standards. Standards do change as knowledge increases.

In implementing the design criteria described in sections 3.2 to 3.5 which follow assistance is provided in Appendix A-V – “Check List for Designing to Counteract Natural Hazards”.

3.2 Design Criteria for Wind

3.2.1 Basic Wind Speeds and Reference Pressures

Different codes and standards define and describe wind forces and speeds differently. Since Caribbean clients have to deal with different standards regimes it is important to be able to convert from one standard to another. The main parameters used in defining wind speeds are:

- averaging period
- return period
- height above ground
- upstream ground roughness
- topography

Thus, in the commonly-used OAS/NCST/BAPE “Code of Practice for Wind Loads for Structural Design”⁵ the definition reads:

“The basic wind speed V is the 3-second gust speed estimated to be exceeded on the average only once in 50 years...at a height of 10 m above the ground in an open situation...”

⁵BNS CP28 - Code of Practice for Wind Loads for Structural Design; sponsored by the Organization of American States, the National Council for Science & Technology and the Barbados Association of Professional Engineers; prepared by Tony Gibbs, Herbert Browne and Basil Rocheford; November 1981.

3.2.2 Caribbean Uniform Building Code (CUBiC)⁶

Figure 1 shows a map of the Caribbean region with isolines of reference velocity pressures taken from CUBiC for 50-year return periods.

Figure 1 - Regional Map of Wind-pressure Contours
(from CUBiC)

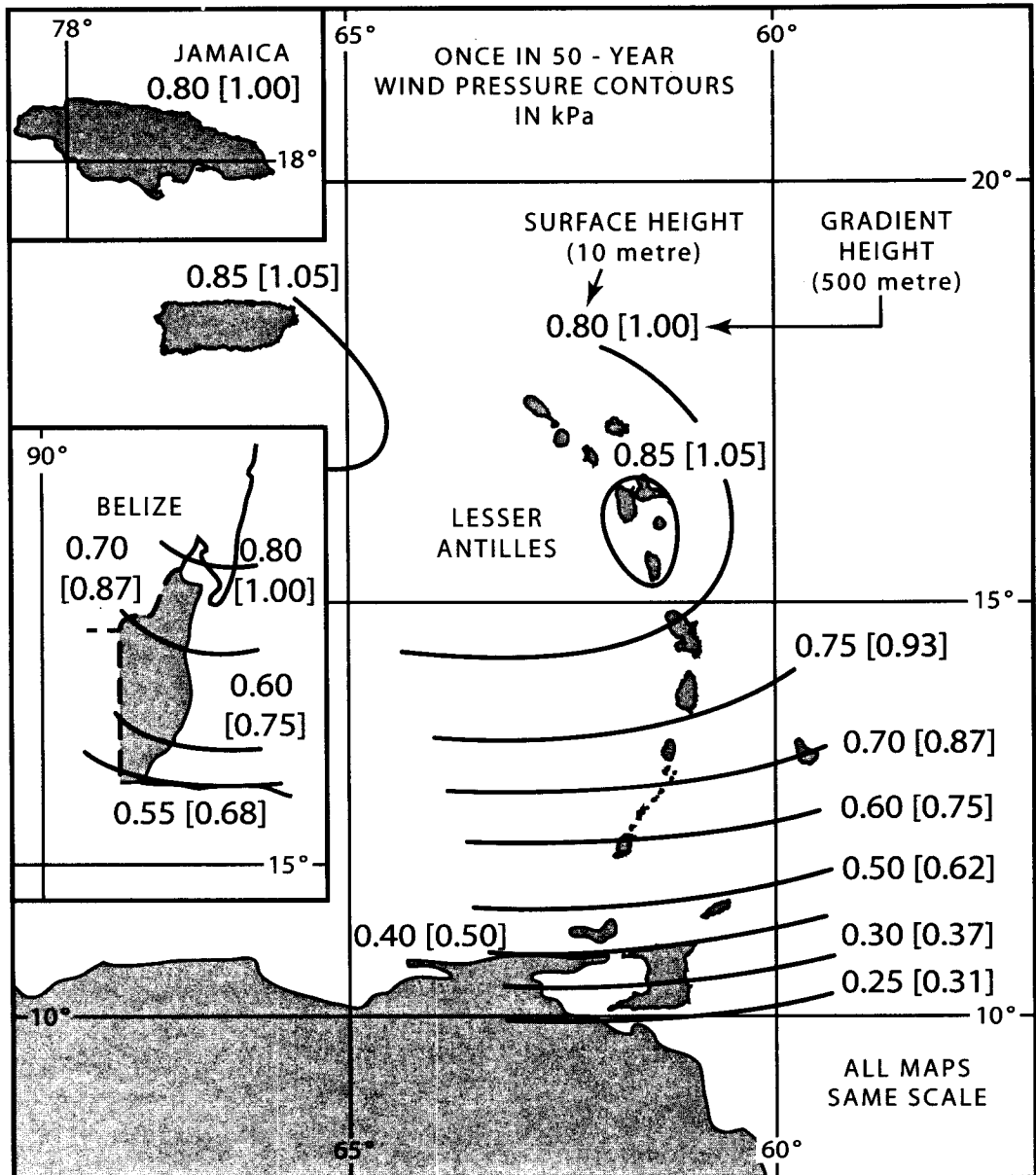

⁶CUBiC Part 2 - Structural Design Requirements; Section 2 - Wind Load; 1985

Table 1 gives the CUBiC reference pressures (50-year return periods) along with corresponding wind velocities for different averaging periods.

Table 1
Reference Wind Velocity Pressures
and Wind Speeds
(50-year return period)
(taken from CUBiC)

Location	q_{ref} CUBiC	10 min CUBiC	1 hr	1 min (or "fastest mile")	3 sec
Antigua	0.82	37	35	45	56
Barbados	0.70	34	32	41	51
Belize - N	0.78	36	34	43	54
Belize - S	0.55	30	29	37	45
Dominica	0.85	38	36	46	57
Grenada	0.60	32	30	38	47
Guyana	0.20	18	17	22	27
Jamaica	0.80	37	35	44	55
Montserrat	0.83	37	36	48	59
St Kitts/Nevis	0.83	37	36	48	59
St Lucia	0.76	36	34	43	57
St Vincent	0.73	35	33	42	56
Tobago	0.47	28	26	38	42
Trinidad - N	0.40	26	25	31	39
Trinidad - S	0.25	20	19	25	30

Notes:

q_{ref} = pressures in kilopascals (kPa)
wind speeds in metres per second (ms^{-1})

3.2.3 Averaging Periods

Figure 2 presents a graph which may be used to convert wind speeds of one averaging period to speeds of another averaging period.

The OAS/NCST/BAPE “Code of Practice for Wind Loads for Structural Design” uses an averaging period of 3 seconds. CUBiC uses an averaging period of 10 minutes. Several Caribbean countries are, or will be, using the USA standard ASCE 7⁷ in their national codes. This standard uses an averaging period of 3 seconds.

Figure 2 - **Wind-speed Variation Averaging Period**
(from Durst)

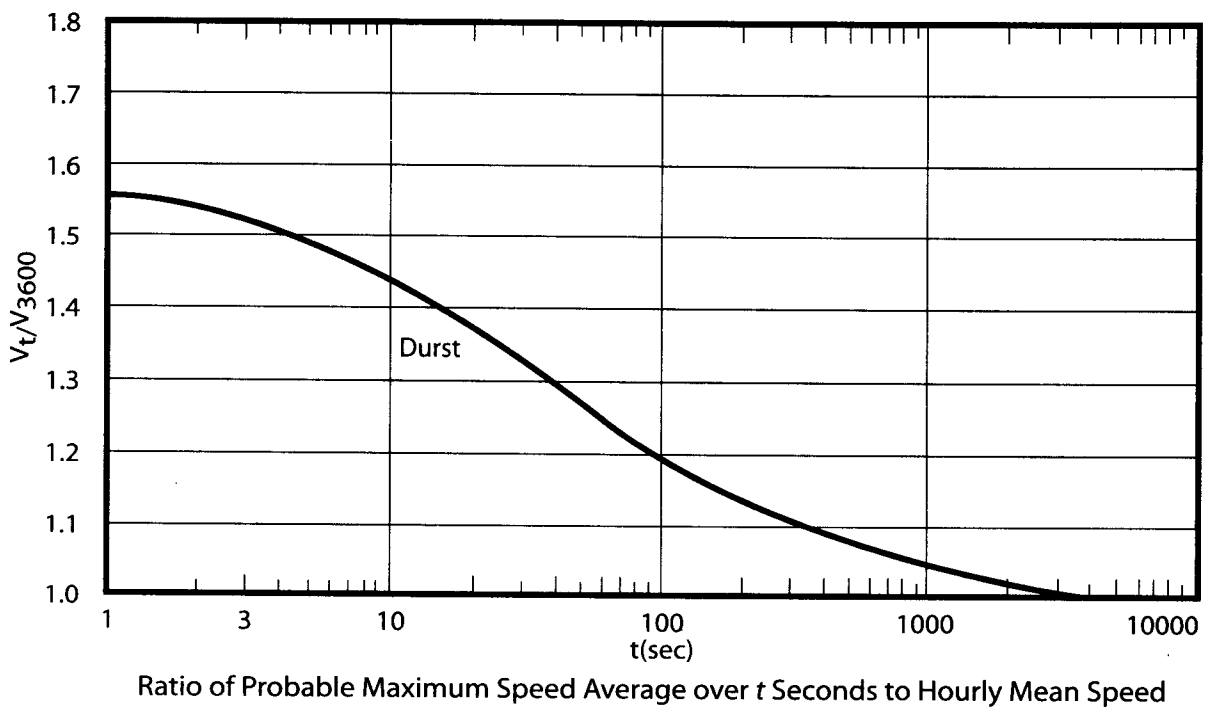

3.2.4 Return Period

The client, in consultation with (and advice from) its consultant, should make conscious decisions with respect to desired levels of safety for different facilities. These decisions can be translated into return periods. The longer the return period the greater the level of safety. Figure 3 presents graphs from the OAS/NCST/BAPE Code addressing this parameter. For most healthcare facilities, a return period of 100 years is the suggested minimum appropriate standard.

⁷American Society of Civil Engineers “Minimum Design Loads for Buildings and Other Structures”, ASCE 7-02 (the most recent edition), Chapter 6.0 Wind Loads, adopted by reference in the International Building Code (a USA model code)

Figure 3 - S₃ Factor for Return Period and Probabilities
(from OAS/NCST/BAPE Code)

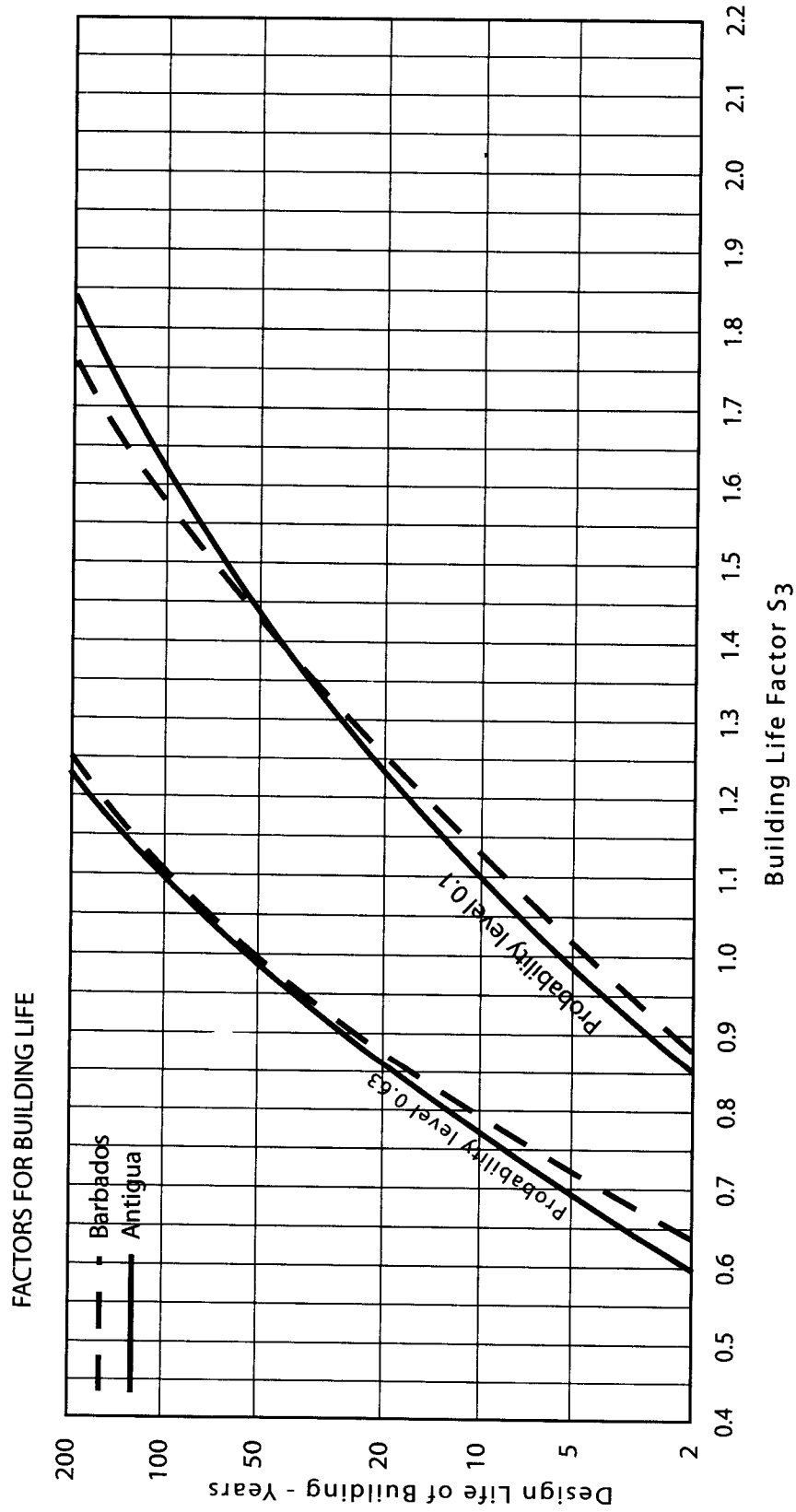

Table 2
Z Values
 (taken from CUBiC)
and Equivalent Seismic Zone Factors and Numbers

Territory	Z Value CUBiC & UBC 85	Z Factor UBC 1988 & SEAOC 1990	Zone Number SEAOC
Antigua	0.75	0.3	3
Barbados	0.38	0.15 - 0.2	2
Belize - (areas within 100km of of southern border, ie including San Antonio and Punta Gorda but excluding Middlesex, Pomona and Stann Creek)	0.75	0.3	3
Belize - (rest of)	0.50	0.2	2+
Dominica	0.75	0.3	3
Grenada	0.50	0.2	2+
Guyana - (Essequibo)	0.25	0.1	1+
Guyana - (rest of)	0.00		
Jamaica	0.75	0.3	3
Montserrat	0.75	0.3	3
St Kitts/Nevis	0.75	0.3	3
St Lucia	0.75	0.3	3
St Vincent	0.50	0.2	2+
Tobago	0.50	0.2	2+
Trinidad - (NW)	0.75	0.3	3
Trinidad - (rest of)	0.50	0.2	2+

3.3 Design Criteria for Earthquake

Much less is known about the earthquake hazard than about the wind and rainfall hazards in the Caribbean. Because of this, and because of the ongoing research in this field, there is the need for regular reviews of design criteria by the construction industry in general and by consultants in particular. There may also be the justification for site-specific and project-specific studies for large or critical facilities.

For most projects, the guidance provided by existing standards and research papers would suffice. Some of these documents are listed below.

3.3.1 Caribbean Uniform Building Code (CUBiC)⁸

Table 2 gives the CUBiC zone factors (Z) for different locations in the region. The table also shows the corresponding values for the Uniform Building Code (USA) and the popular Structural Engineers Association of California (SEAOC) code.

3.3.2 PAIGH⁹ Research

Figures 4a and 4b show maps of the Caribbean region with isolines of accelerations due to earthquakes based on a research programme which was completed in 1994 and published in 1997¹⁰. The Caribbean part of the project was under the leadership of Dr John Shepherd. The maps show the Peak Horizontal Ground Acceleration or PGA (0.2 second) and the Spectral Ground Acceleration or SGA (1.0 second). They are based on a 10% probability of being exceeded in any 50-year period.

More recently Professor John Shepherd of the SRU¹¹ updated the maps for the Eastern Caribbean to include data up to the end of 2002. These maps (Figs 4c and 4d) show the spectral ground acceleration at periods of 0.2 seconds and 1.0 seconds with 2% probability of exceedance in any 50-year period. This brings the Eastern Caribbean maps into line with current practice in the United States. These parameters are the bases for the NEHRP¹², ASCE 7¹³ and IBC¹⁴ standards. These USA standards documents are likely to inform the future earthquake loading standards of most Caribbean countries.

⁸CUBiC Part 2 - Structural Design Requirements; Section 3 - Earthquake Load; 1985

⁹Instituto Panamericano de Geografía y Historia

¹⁰Seismic Hazard in Latin America and the Caribbean - Final Report; Instituto Panamericano de Geografía y Historia; Volume 1 (JG Tanner, JB Shepherd); Volume 5 (JB Shepherd, JG Tanner, CM McQueen, LL Lynch); 1997

¹¹Seismic Research Unit of The University of the West Indies in Trinidad

¹²National Earthquake Hazards Reduction Program (of the USA)

¹³American Society of Civil Engineers "Minimum Design Loads for Buildings and Other Structures", ASCE 7-02 (the most recent edition), Chapter 9.0 Earthquake Loads

¹⁴International Building Code IBC2003 (a USA model code)

Figure 4a

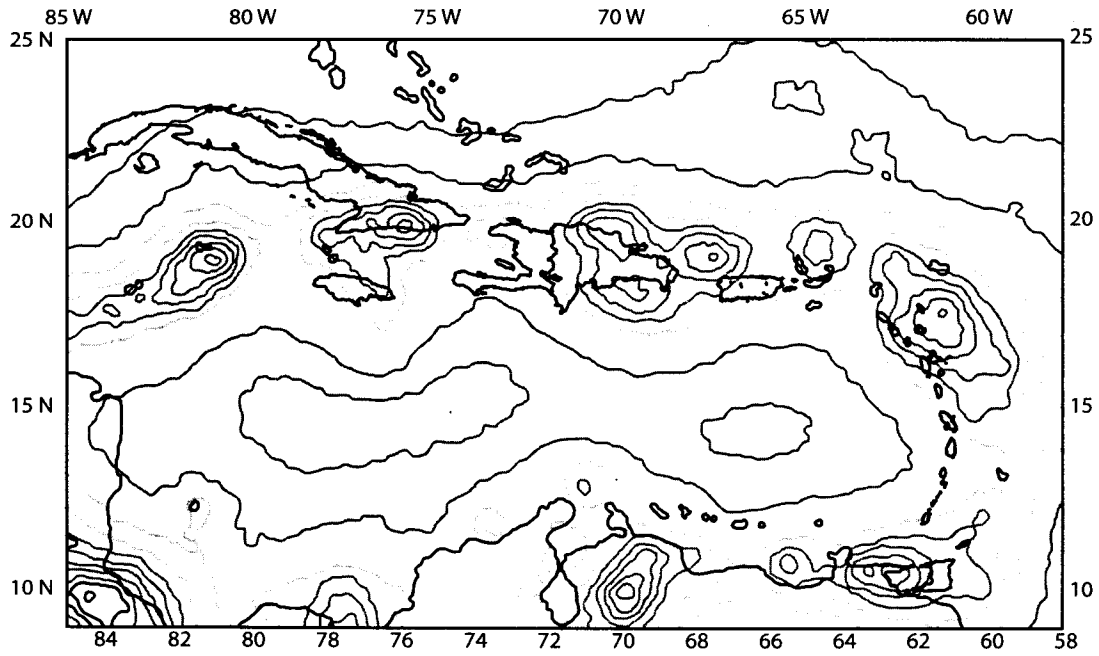

Spectral acceleration at 0.2 second period
with 10% probability of exceedance in any 50-year period

Figure 4b

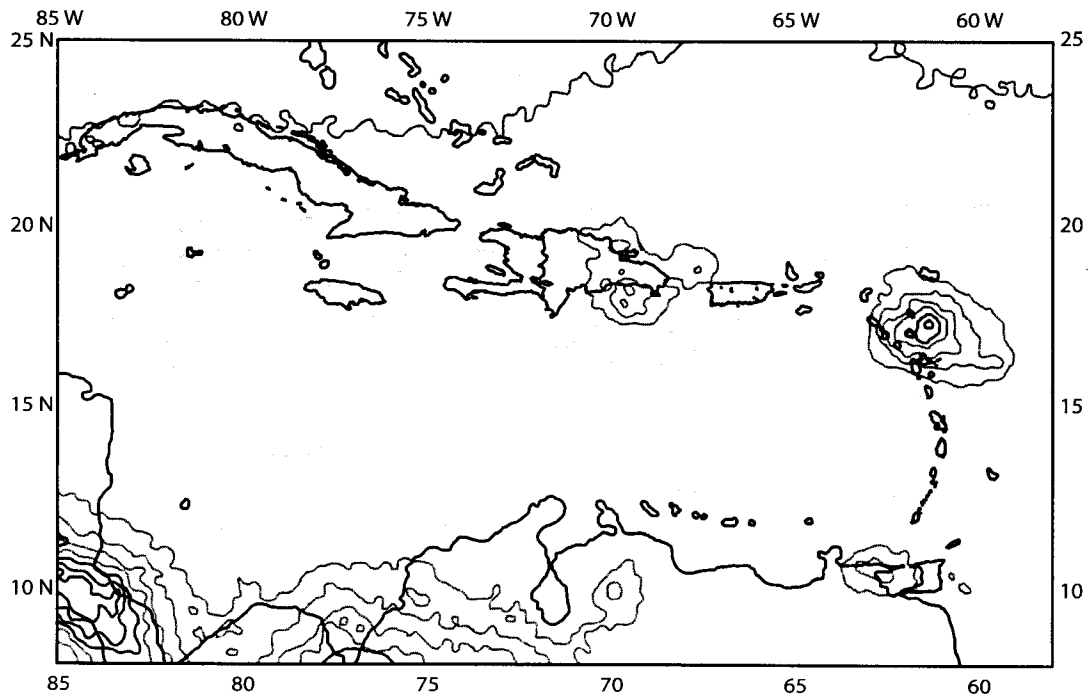

Spectral acceleration at 1.0 second period
with 10% probability of exceedance in any 50-year period

Figure 4c

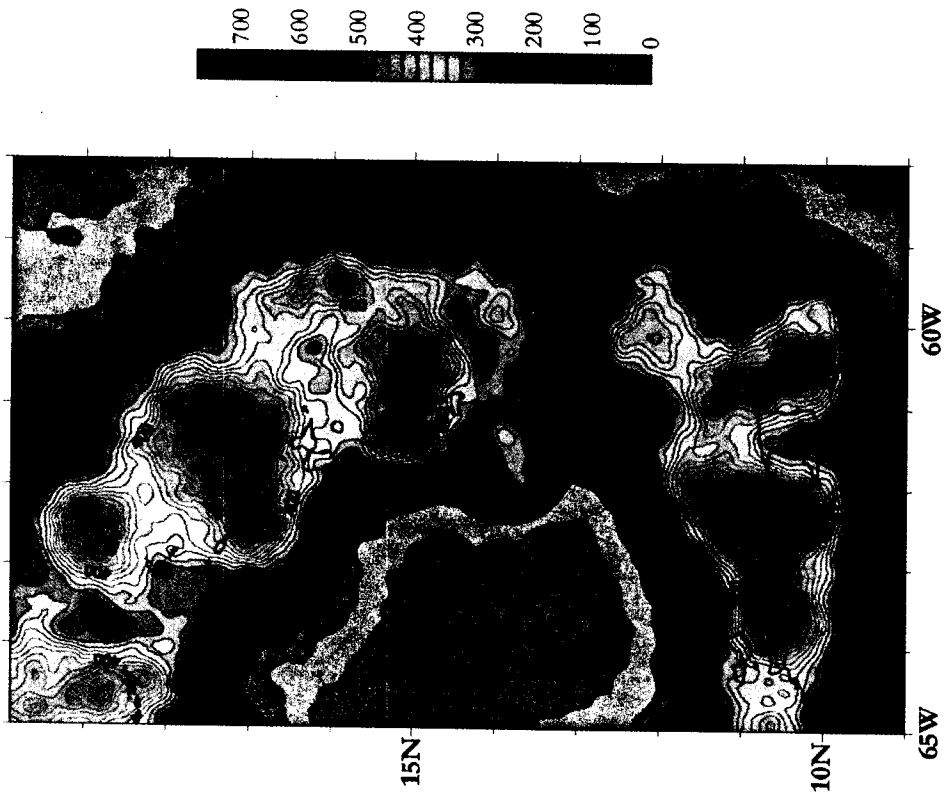

Spectral acceleration at 0.2 second period with 2% probability of exceedance in any 50-year period. Units are gals and the contour interval is 25 gals. To convert to g divide by 981.

Figure 4d

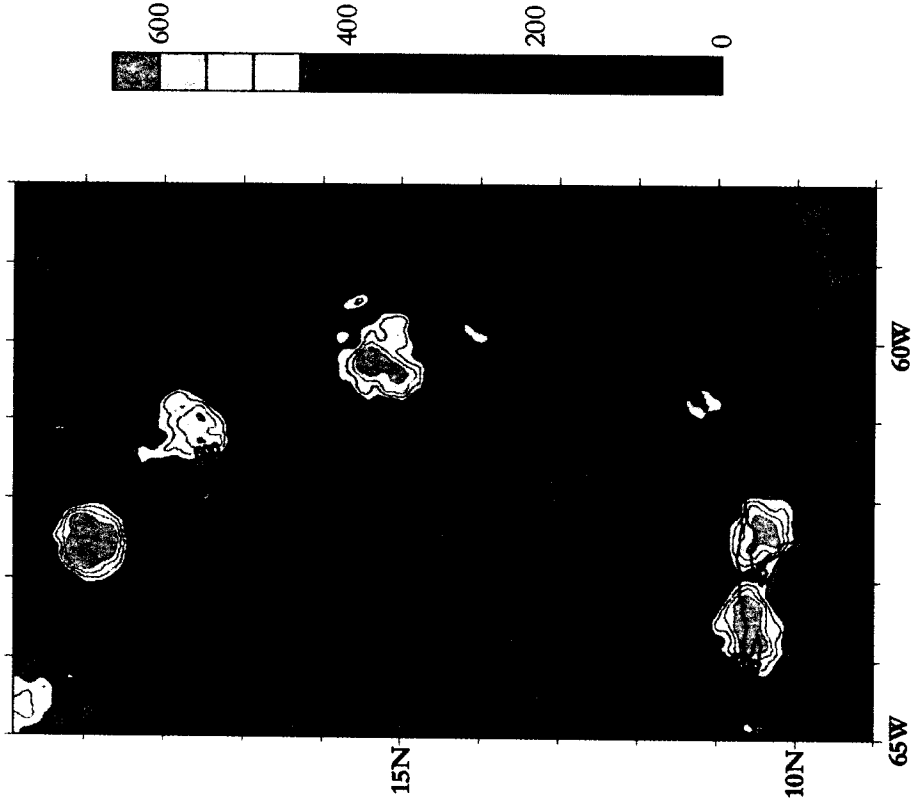

Spectral acceleration at 1.0 second period with 2% probability of exceedance in any 50-year period. Units are gals and the contour interval is 25 gals. To convert to g divide by 981.

3.3.3 Importance Factor

Earthquakes are not yet amenable to statistical analysis and to the determination of return periods in the same way as windstorms or rain. Nevertheless the client, in consultation with the consultant, must still make conscious decisions with respect to desired levels of safety for different facilities. These decisions are translated into importance factors in codes and standards. These factors usually vary from 1.0 to 1.5. For healthcare facilities, an importance factor of 1.2 is the suggested minimum appropriate standard and for the critical facilities of referral hospitals the highest factor (1.5) should be used.

3.3.4 Concept

Satisfactory earthquake-resistant design requires more than the faithful following of the mathematical requirements of standards documents. Appropriate geometry of the overall building or structure and appropriate structural systems are critical for success.

3.3.5 Detailing

Good conceptual design and good analysis must be complemented by good detailing in order to achieve satisfactory performance of buildings and other facilities in earthquakes.

3.3.6 Moving the Goalposts

In most Caribbean islands healthcare facilities operate in normal times with little or no spare capacity. In the aftermath of a major earthquake the times are certainly not normal. In such circumstances it is vital that the healthcare facilities operate at close to optimum efficiency.

The conventional and traditional approach to earthquake-resistant design is to resist minor earthquakes without damage, to resist moderate earthquakes without structural damage (but tolerating non-structural damage which may include damage to electrical and mechanical systems) and to resist major earthquakes without collapse. In other words, emphasis is placed on saving lives, not on saving facilities. This would no longer do for hospitals and other some other healthcare facilities.

There are two aspects that must be addressed in the new, proposed paradigm for healthcare facilities - the improved performance of non-structural components and the mitigation of damage to load-bearing structures through the use of response-reducing devices.

Energy isolating and dissipating devices are no longer untried. Many successful installations have been completed in several countries. These devices protect buildings by limiting the energy entry at source (eg base isolation) or by providing energy-dissipating devices within the structure. By so doing it becomes feasible to move the goalposts with respect to performance expectations.

The aim is to design healthcare facilities so that they function with little degradation in efficiency in times of major earthquakes.

It is recommended that base isolation and energy dissipating devices be investigated for feasibility at an early stage in the conceptual design of hospitals. To assist in the appreciation of this concept, Appendix A-VI – “Base Isolation for Buildings” provides a brief description of the main issues which must be considered by designers.

3.4 Design Criteria for Torrential Rain

3.4.1 Design Graphs

Intensity-duration-frequency curves have been developed for several territories in the region and may be available through the Caribbean Institute for Meteorology and Hydrology in Barbados. A sample is given in Figure 5.

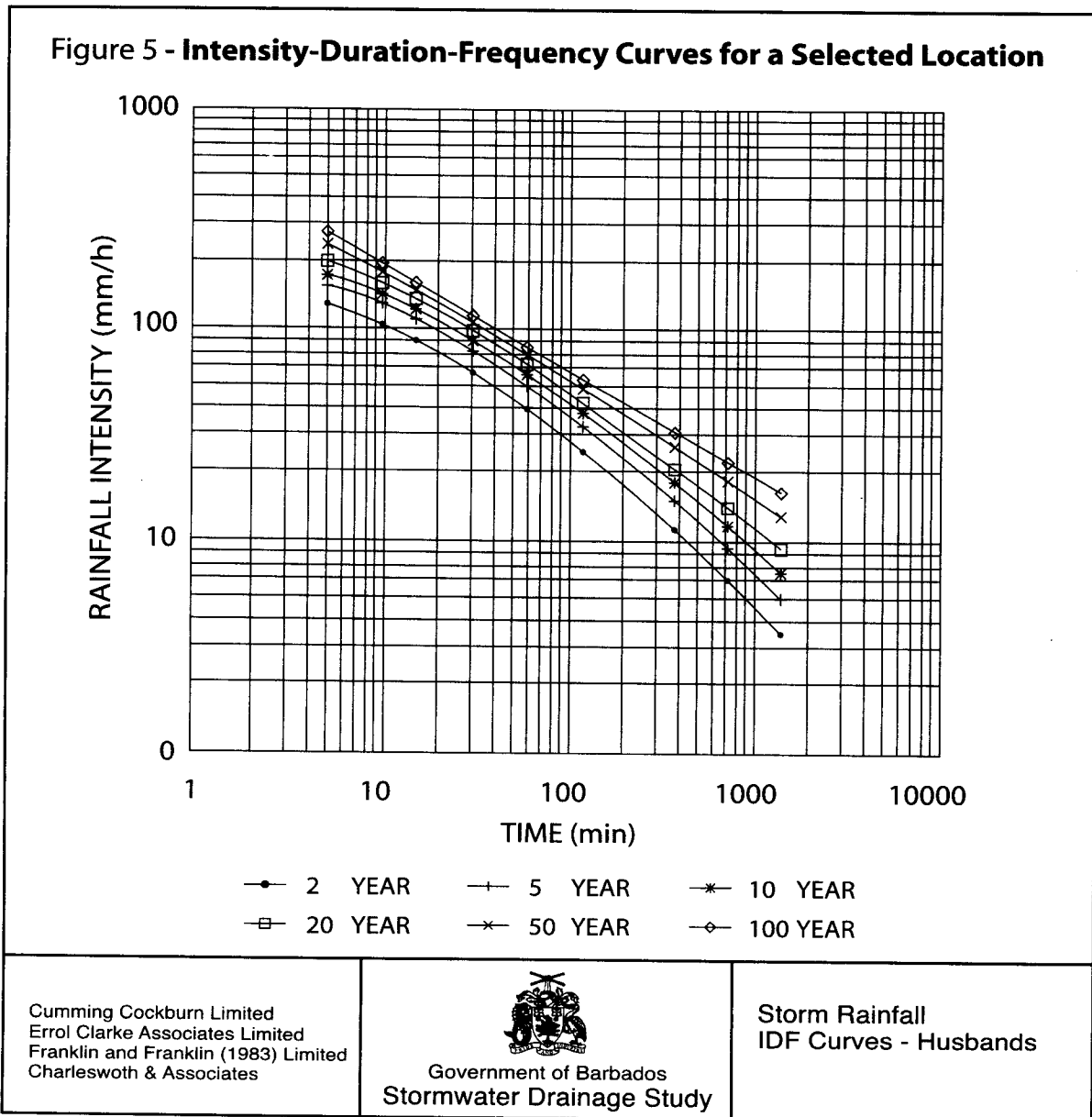

3.4.2 Return Period

Traditionally, quite short return periods have been selected for design rain storms. It was quite common for facilities to be designed for 1-in-20-year storms. Much damage and disruption is caused with increasing frequency by torrential rains. There needs to be a reassessment of this design criterion. For healthcare facilities, a return period of 50 years is the suggested minimum appropriate standard.

3.4.3 Changing Conditions

The other factor affecting rain runoff and flooding is upstream development, usually outside of the control of the client for a particular facility. It is not unlikely that well-designed drainage systems prove to be inadequate some time after they have been implemented because of greater runoff than could reasonably have been anticipated at the time of design. This typically happens when land use upstream is changed due *eg* to urban expansion. Therefore it is appropriate to adopt a conservative approach to the selection of rainfall design criteria.

3.5 Design Criteria for Storm Surge and Tsunami

3.5.1 Storm Surge

This complex phenomenon is of interest for coastal sites. Computer models are available for developing storm-surge scenarios for coastlines. One such model is TAOS (The Arbitrator of Storms) developed by Charles C Watson and tailored for the Caribbean under the USAID/OAS-CDMP¹⁵ programme. This model is now operational at the Caribbean Institute for Meteorology and Hydrology in Barbados.

3.5.2 Tsunami

Figure 6 shows a credible scenario from a likely eruption of the Kick 'em Jenny submarine volcano just north of Grenada. It is not commonly remembered that the great Lisbon (Portugal) earthquake of 1755 generated a significant tsunami in Barbados and in the 19th century many lives were lost in the (now) US Virgin Islands due to a tsunami generated by a nearby earthquake.

3.5.3 Advice

The studies of both of these hazards are highly specialised subjects for which expert advice should be sought for all low-lying, coastal developments.

¹⁵Caribbean Disaster Mitigation Project; funded by the United States Agency for International Development; implemented by the Organization of American States

Figure 6 - Tsunami Heights for Realistic Kick 'em Jenny Eruption
 (from Martin Smith & John Sheperd - 1992 VRI = volcanic explosive index)

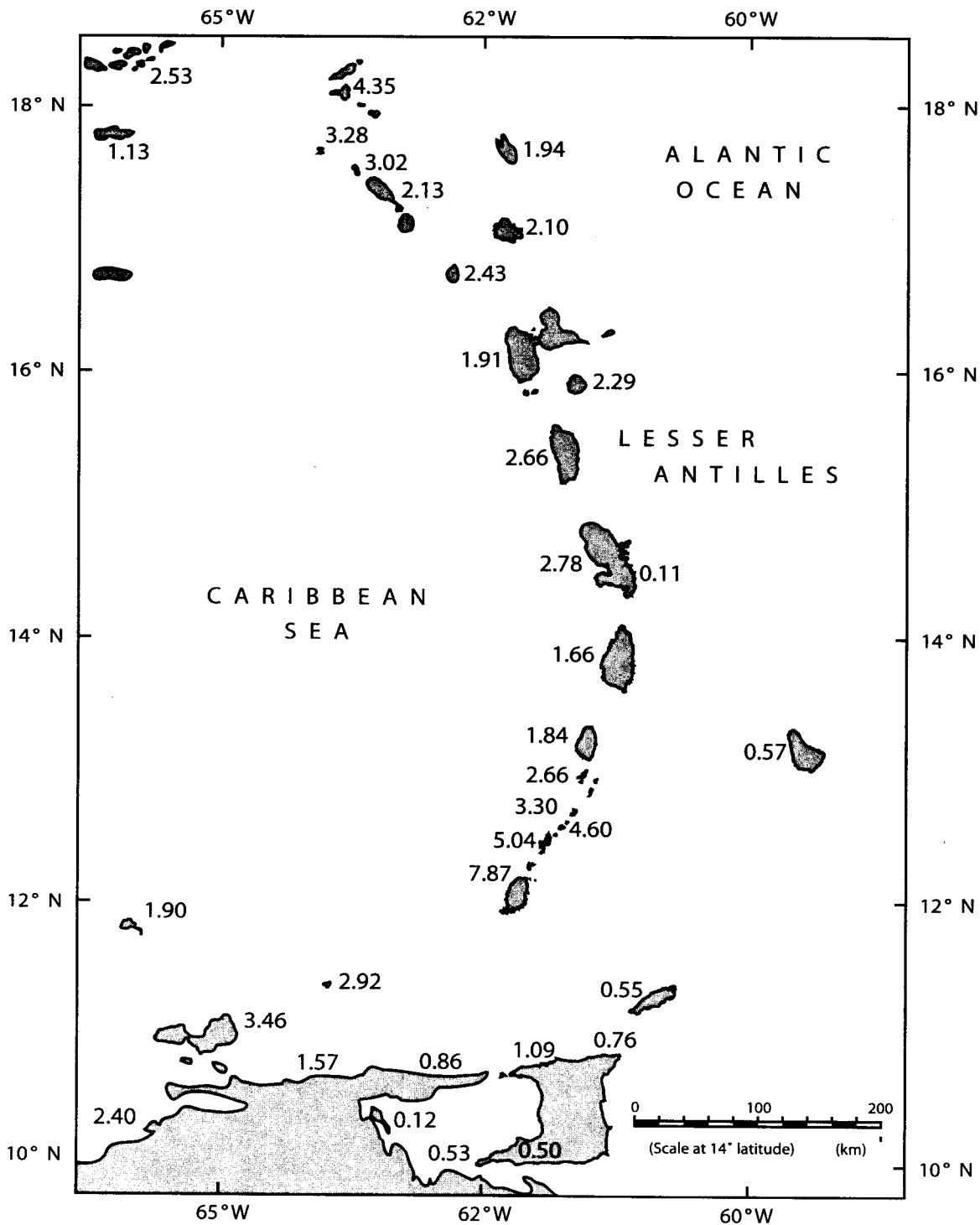

Final run-up values in metres for a 'realistic' scenario event at Kick 'em Jenny (VEI = 3).

3.6 Design Guidance for Explosions

Explosions may occur by accidental means such as defects in the gas supply. In these days there is also the possibility, however remote, of terrorist activity involving bombs. Because of these issues it is considered appropriate for some general guidance to be provided to those involved in the design of healthcare facilities.

Fortunately, the general principles of designing for explosions coincide with those for earthquake-resistant design and, in the case of windows, with those for hurricane-resistant design.

Appendix A-VII – “Design of New Buildings Considering the Explosion Hazard” provides information suitable for the conceptual design stage of projects.

3.7 Design Guidance for Fire

The design for fire protection, fire resistance and fire extinction should be carried out in compliance with the relevant national standards. In several Caribbean countries such standards do not exist or are outdated or are inadequate. Where this is known to be the case the designers should resort to standards from another jurisdiction. An appropriate set of standards which may be used as “default” guidance is that of the National Fire Protection Association (NFPA) of the USA. NFPA 101 generally covers fire/safety requirements only.

For existing hospitals the Fire Safety Evaluation System (FSES) of the USA may be useful.

Issues to be addressed include:

- compartmentation;
- exits;
- fire alarms;
- automatic extinguishing systems;
- other fire prevention and fire protection measures.

The installation of fire and smoke dampers requires special consideration. These dampers should be constructed, located and installed strictly in accordance with the relevant national code or in accordance with the requirements of NFPA 101 and those of the manufacturers. Fans, dampers and detectors should be interconnected so that damper activation will not damage ducts. Maintenance access should be provided at all dampers. Dampers should be activated by fire and smoke sensors, not by fan cutoff alone. Switching systems for restarting fans may be installed for fire department use in venting smoke after a fire has been controlled. However, provision should be made to avoid possible damage to the system due to closed dampers. When smoke partitions are required, airconditioning zones should be coordinated with compartmentation insofar as is practical to minimise the need to penetrate fire and smoke partitions.

All healthcare facilities should be provided with fire alarm systems.

4 NON-STRUCTURAL COMPONENTS¹⁶

4.1 General

Non-structural components are the orphans of the building industry. No one pays proper attention to their safety. They include ceilings, windows, doors, external cladding and many other components of buildings. Non-structural components comprise 60 to 80 percent of the cost of a building. In the case of referral hospitals the figure is closer to the higher number. Since consulting structural engineers usually do not get paid for designing these elements they are not dealt with by this group. Since the training of architects does not equip them to address the strength and stability issues associated with these elements they leave these matters to the suppliers and contractors. Codes and standards are almost silent on these matters. The suppliers and contractors, recognising that no one is paying attention to strength and stability issues, concern themselves mainly with function, appearance and price. A high percentage of the losses in hurricanes and earthquakes is due to the failure of such non-structural elements.

It is understood that the structural design of non-structural components in Colombia is now becoming a clearly recognised function with a particular (additional) member of the design team being allocated the task.

4.2 Fixed Components to be Considered by Design Professionals

In the case of earthquakes all non-structural components of the building require attention. They include electrical and mechanical systems, ceilings, partitions, cupboards and shelves, windows and doors.

Assistance to the designer is provided in Appendix A-VIII – “Check List for Non-structural Components for Earthquakes”.

In the case of hurricanes and torrential rain the non-structural components warranting attention are all of those comprising the building envelope and all of those located outside of the building envelope. Since the design aim for hurricane resistance is to have no significant damage to the building (in contrast to the traditional design aims for earthquake resistance) it is assumed that the building envelope is not breached during the event.

Apart from roofs, the elements requiring the most attention for hurricanes are windows and external doors. Sadly, these are often neglected even when buildings are formally designed by professionals. Glass windows and doors are, of course, very vulnerable to flying objects, and there are many of these in hurricanes. There are only two solutions: use impact-resistant glazing (expensive but highly desirable) or cover the glass with storm shutters (inconvenient in a hospital situation). For new buildings the challenge is to design storm shutters which are integrated into the permanent structure, have

¹⁶Non-structural components are those not required for the support of floors and roofs. Their removal should not lead to damage to the building structure.

another role which they could play every year (eg sun shading and burglar proofing) and enhance the appearance of the building. It is not sufficient to protect fragile glass however. Attention must also be paid to securing external doors with strong bolts or braces and to fixing door and window frames firmly to the walls.

Assistance is provided in Appendix A-IX – “Check List for Non-structural Components for Hurricanes”.

4.3 Movable Items to be Addressed by the Hospital Staff

In addition to the building itself (structure and non-structure) there are the items of movable equipment and furniture in hospitals. In the case of earthquakes (which provide no warning as to the exact time of occurrence) there is the need to secure the stability of such objects. Much furniture and some equipment in hospitals are on wheels. These wheels must be provided with brakes or other restraints. The challenge here is to persuade (by training) the staff always to engage the brakes or restraints whenever the wheeled items are not actually being moved. The better system is one where the brake or restraint is engaged at all times unless temporarily disengaged by spring-loaded levers as in the case of some baggage trolleys at airports.

These issues are to be considered by those responsible for procuring equipment and furniture for hospitals and by those responsible for training the staff.

5 VULNERABILITY AUDITS AND SETTING IMPLEMENTATION PRIORITIES

5.1 Vulnerability Audits

Various audits of healthcare facilities have been carried out during the past decade by PAHO with funding from the Humanitarian Aid Office of the European Commission (ECHO). The reports on these audits have been collected and are available from PAHO on a CD-ROM.

In addition, useful post-disaster information and assessments can be obtained from the report titled “Survey of the Damage Done to the Government Health Service Facilities in Antigua, Hurricane Luis, September 1995” by Tony Gibbs, Consulting Engineers Partnership Ltd. This is available from PAHO.

Useful guidance on the process for audits may be obtained from the document “Vulnerability Assessment of Shelters in the Eastern Caribbean” prepared for the Organization of American States under the USAID/OAS Caribbean Disaster Mitigation Project by Tony Gibbs, Consulting Engineers Partnership Ltd, November 1998.

5.2 Priorities

This issue can only be addressed with respect to a particular country or ministry of health. Damage mitigation is best done in a phased programme so as not to disrupt the principal functions of the healthcare system. Further, damage mitigation is an ongoing

exercise and not a one-time, crash programme. It ought to become an integral part of the culture of the ministry.

The speed with which the initial, catch-up phase proceeds depends on financial resources, the seriousness of the problem and the size of the problem. Techniques are available for assisting with the decision-making process when determining priorities. Such techniques often involve cost-benefit analyses. Reference should also be made to Appendix A-X – “Rational Approach to Determining Priorities for Retrofitting Healthcare Buildings”.

6 RETROFITTING AND MAINTENANCE OF EXISTING FACILITIES

6.1 Maintenance, Repairs and Replacement as a Tool for Mitigation

Ensure that an adequate maintenance programme is in place. The maintenance budget should be of the order of 4% of the current value of the building/facility per annum and should address:

- metal-work and timber-work;
- equipment for occasional use (stand-by) to be regularly tested by its periodic use;
- repairs leading to moderate improvements;
- replacements leading to significant improvements (repair v replacement is an economic issue to be addressed in this exercise)

Detailed guidance is given in Appendix A-XI – “Maintenance As A Tool For Mitigation”

Regular staff training in the use and operation of equipment is an important aspect of maintenance if the cost of replacement of such equipment is to be kept within reasonable limits.

Reference should also be made to Section 4.3 of this Manual.

6.2 Other Issues

Increasingly governments are having to carry catastrophe insurance of healthcare facilities. In part this is due to the demands of lending agencies by way of collateral for the loans. To maintain a good relationship with the insurance industry and to benefit from more-favourable catastrophe-insurance premiums, high quality maintenance programmes should be adhered to by ministries of health.

APPENDICES

APPENDIX A-I

SELECTING CONSULTANTS

1 Two Critical Characteristics

- 1.1 Precise professional performance specifications cannot be written. The interpretation of terms of reference will vary from firm to firm and, therefore, different levels of service are inevitable.
- 1.2 Successful consulting engineering and architectural services depend on a sufficient amount of time being spent by competent and knowledgeable persons in an efficient manner on the assignment. This translates into adequate compensation. Inadequate compensation eventually leads to inadequate engineering and architecture and greater life-cycle costs.

2 Selection Criteria

- 2.1 Qualification and experience of firms and/or principal players
- 2.2 Specific knowledge of designing against natural hazards within the design team
- 2.3 Capacity and work-load of consultants
- 2.4 Local knowledge and presence
- 2.5 Professional independence and integrity
- 2.6 Cost of services

3 Selection Procedures

- 3.1 Draft the terms of reference.
- 3.2 Draw up a short list of not more than four consulting firms in each required discipline.
- 3.3 Request proposals which should contain:
 - 3.3.1 past experience of projects of a similar nature
 - 3.3.2 details of organisation, project control and financial control
 - 3.3.3 size and responsibilities of staff
 - 3.3.4 type of organisation and managerial method proposed for the execution of the work
 - 3.3.5 quality assurance procedures
 - 3.3.6 knowledge of local conditions and local resources
 - 3.3.7 technical approach to the project
 - 3.3.8 availability of resources
 - 3.3.9 approach and commitment to technology transfer

- 3.4 Assess proposals, negotiate with the selected firms and conclude agreements.
- 3.5 As an alternative to the competitive method outlined in items 3.2 to 3.4 the ministry of health may chose to select consultants based on first-hand knowledge and past relationships. This is often the safest approach.

APPENDIX A-II

TERMS OF REFERENCE FOR DESIGN CONSULTANTS

1 Briefing

The consultants will receive briefs from the client. In particular, the consultants will initiate specific discussions on natural hazards and reach agreement with the client on performance expectations for the project. The client's policy position with respect to natural hazards and the performance expectations in the event of differing levels of severity of hurricanes, earthquakes, torrential rains and other phenomena is to be clearly articulated. Decisions must be made on the appropriate levels of safety for the planned facilities. This is addressed further in Section 3 of the main part of the Manual.

2 Specific Discussion on Natural Hazards and Agreement of Performance Expectations

Experience has shown that the design against natural hazards is not something that ministries of health can take for granted. At the outset the representatives of the ministry of health should hold discussions with its consultants and clearly articulate the policy position of the ministry with respect to natural hazards and the performance expectations in the event of differing levels of severity of hurricanes, earthquakes, torrential rains and other phenomena.

3 Steps in the Monitoring of Consultants and Approval Stages

3.1 Inception Report

3.2 Preliminary design and cost estimates

3.3 Review and "sign off" on agreed damage mitigation measures

3.4 Tender documents

3.5 Approved list of tenderers (construction contractors)

3.6 Contract award

3.7 Monthly reports during construction

3.8 Taking possession of constructed facility and the maintenance period

3.9 Final certification and receipt of all manuals and as-built drawings

4 Document Search and Interviews

The consultant will request from the client and receive all available reports related to the project and the site.

After study of the available documents the consultant will carry out interviews of the technical and other personnel of the client to supplement the information on the project obtained from the documents.

4.1 Inception Report

On completion of the document review and supplementary interviews the consultant will prepare an inception report including:

- the consultant's understanding and interpretation of the terms of reference;
- changes to the terms of reference since the start of the assignment;
- an appraisal of the available information and an outline of the consequential field investigations to be conducted so as to complement the information already obtained, including any special investigations which may be required;
- an outline of the programme for the remainder of the assignment.

5 Field Surveys and Laboratory Tests

The consultant will carry out field surveys to supplement and confirm previously-obtained information. Such field surveys may include laboratory testing of materials taken from the site.

For the assessment of storm-water drainage provisions it may be necessary for the consultant to undertake topographic surveys of the site.

For the assessment of foundation conditions affecting anchorage and the seismic response of facilities it will be necessary for the consultant to undertake geotechnical surveys of the site and it may be necessary to undertake geophysical surveys as well.

6 Preliminary Appraisals, Conceptual Design and Project Definition

The consultant will interpret the brief and prepare conceptual designs for consideration by the client.

The design, analysis and detailing of buildings to be resistant to earthquakes and hurricanes are complex processes involving many issues. As an *aide-mémoire* for detailed engineering, Appendix A-V – “Check List for Designing to Counteract Natural Hazards” is included in this document. Hospital planners and architects usually dominate this phase of a project. It is important that they receive early advice from the engineers on the design team on the implications for the design concepts of natural hazards.

6.1 Design Stage I Report

On completion of the work described in 5 and 6 the consultant will prepare a design stage I report including:

- the design standards and codes to be used on the project;
- the agreed design criteria for the project;
- preliminary design and drawings;

- outline specification;
- procurement procedures for the construction contractors and suppliers;
- conditions of contract - general and particular;
- cost estimates;
- an outline of the programme for the remainder of the assignment.

The client will review the report and hold discussions with the consultant (which may lead to revisions) and will conclude with the formal approval of the project, as defined in the report, for implementation.

The vulnerability of a building to earthquakes and hurricanes is very often associated with the non-structural components of the building. These components rarely receive the attention they deserve from the construction industry. As *aides-mémoire* Appendices A-VIII – “Check List for Non-structural Components for Earthquakes” and A-IX – “Check List for Non-structural Components for Hurricanes” are included in this document addressing this issue.

In modern hospitals those elements not part of the principal load-resisting system account for approximately 80% of the cost. Traditionally, structural engineers are not consciously and directly involved with these elements. Architects, electrical engineers and mechanical engineers are usually responsible for them. These disciplines do not usually focus on wind and earthquake resistance. In most cases the relevant persons are by no means equipped for the task of providing wind-resistant and earthquake-resistant components. The solution of this problem may involve the reallocation of design responsibilities among the members of the design team with a commensurate reallocation of compensation.

This stage effectively defines the project. It is therefore most important that it be done thoroughly by the design team and be reviewed carefully by the client. The likelihood is that a satisfactory Design Stage I phase would lead to a successful project.

7 Design Stage II

The consultant will undertake the detailed design, analysis and detailing of all aspects of the works to be constructed. This phase of the project will include:

- the iterative process of analysis and refinement of the designs;
- construction details;
- technical specifications;
- bills of quantities.

8 The Tender Process

The consultant will undertake the following tasks:

- prequalification of contractors and suppliers;
- inviting tenders;
- pre-tender meeting with the bidders;
- answering questions from bidders during the tender period;
- opening of tenders, review and reporting on tenders.

The tender process culminates with the client's decision and the contract award by the consultant on behalf of the client.

9 Construction Stage

The consultant will undertake the following tasks:

- conduct a pre-construction meeting with the chosen contractor;
- undertake supervision-in-chief, provide resident supervision in appropriate circumstances and advise the client on the need for additional inspectors;
- conduct site meetings and prepare progress reports for issue to the client;
- check shop drawings and provide approvals when compliance with the contract documents is achieved;
- issue and administer variations and additions to the contract;
- certify payments to the contractor;
- issue the certificate of substantial completion;
- monitor latent defects during the maintenance period;
- deliver as-built drawings to the client.

At the end of the maintenance period the consultant will carry out a final inspection of the works and issue the final certificate for payment to the contractor.

APPENDIX A-III

CHECK LIST FOR THE DESIGN TEAM LEADER

(In this case the team leader is assumed to be an architect and what follows is based on the work of Christopher Arnold who is an architect.)

1 Inception and Feasibility Stages (RIBA¹⁷ work stages A&B)

The architect reviews the project with the engineer before any design begins. Matters to be addressed are:

Issues for Review:

Building size:	gross area floor area probable number of floors
Site characteristics:	geology foundation characteristics zoning restrictions: plan area height limit orientation
Interior planning:	types of spaces: large small circulation requirements: vertical horizontal special planning requirements
Fire standards:	code options
Budget:	general level of quality

Structural decisions:

Seismic code:	determination of applicable standard
Wind code:	determination of applicable standard

2 Outline Proposals (RIBA work stage C)

The architect reviews the following matters with the engineer very early in the development of the building configuration. Complex plans or significant configuration issues should be brought to the engineer's attention at the earliest possible point so that their implications can be assessed.

¹⁷Royal Institute of British Architects – Their procedures are commonly followed by most architects in the Commonwealth Caribbean.

Issues for Review:

- Configuration: shape
size
number of floors
significant configuration problems
floor-to-floor heights; variations in height
- Vertical circulation: stairs
elevators
cores:
 - size
 - location
- Mechanical systems: general type
distribution pattern
required space for ducts
- Materials: code requirements
cladding

Structural decisions:

- Structural strategies: horizontal framing
vertical framing
lateral systems:
 - moment-resistant frames
 - shear walls
 - braced framesperimeter requirements
special aesthetic requirements

3 Scheme Design (RIBA work stage D)

Matters for consideration are:

Issues for review:

- Architectural systems: exterior cladding
interior partitions
ceilings
depressions in floor slabs
vertical transportation
- Mechanical/Electrical: airconditioning and other distribution networks
preliminary duct sizes and locations
openings in floors, walls, beams, girders
equipment locations:
 - roof
 - floors

basement
vertical shafts
lighting

Structural decisions:

Structural system: bay size
horizontal framing:
materials
foundation requirements
vertical/lateral framing
shear wall / braced frame locations

Preliminary analysis: preliminary member sizing
preliminary seismic details

4 Detail Design and Production Information (RIBA work stages E&F)

Matters for consideration are:

Issues for review:

Architectural systems: interior partitions
exterior cladding
ceilings
vertical shafts
stairways
floor slab depressions

Mechanical/Electrical: responsibility for seismic safety
duct size and locations
piping size and locations
treatment at crossings of separation joints
size, weight, location of all major equipment
all required penetrations of floors, roofs, walls, shafts and
beams
lighting systems

Structural decisions:

Structural design: member sizes, locations
final structural analysis
connection details
review of shop drawings

APPENDIX A-IV

INDEPENDENT REVIEWS

1 Hurricane Luis in Saint Martin / Sint Maarten

In September 1995 Hurricane Luis passed to the north-east of the island of Saint Martin / Sint Maarten. Saint Martin is French and Sint Maarten is Dutch. The amount of damage in Sint Maarten was significantly more than in Saint Martin, although the French side of the island was closer to the centre of Luis than was the Dutch side.

It is accepted that factors other than distance from the eye of the storm, such as topography, affect wind speeds. However, there is no clear evidence that Sint Maarten experienced higher wind speeds than the French side. Unfortunately there were no anemometer measurements available on the French side and the only reliable anemometer readings on the Dutch side were at the Netherlands Antilles Meteorological Service at the airport. There the highest recorded gust¹⁸ was 99 knots or 51 metres per second (ms^{-1}). This was at a height of 10 metres above adjacent ground.

The eye passed 50 kilometres north of Saint Martin / Sint Maarten so that it was the south-west, south and south-east eye walls that impacted on the island. This meant that Saint Martin / Sint Maarten was spared the full brunt of Luis. Indeed, the wind forces in the north eye wall would have been about 33% greater than those in the south eye wall.

Notwithstanding the relatively favourable location of the island, the amount of damage caused was significant. In the case of Dutch Sint Maarten the damage was catastrophic. Direct losses were equivalent to the gross domestic product (GDP) and indirect losses added a similar amount, for a total loss of the order of twice the GDP¹⁹.

When Tony Gibbs visited the shared island in May 1996, eight months after Luis, the Dutch side still showed considerable evidence of the damage due to Luis. This was not at all evident on the French side. How much of the difference was due to differing responses on the two sides he was unable to tell. However, those who were there during and immediately after the event confirmed that the differences in levels of damage were stark.

2 The Differing Regulatory Regimes

During Gibbs' visit to Sint Maarten meetings were held with several engineers and builders who had worked on both sides of the island. The contrast in damage levels was discussed with them and their comments were revealing.

¹⁸One to three seconds duration

¹⁹These figures are based on an assessment carried out by the United Nations Economic Commission for Latin America and the Caribbean (ECLAC)

Mr Ronald Daal of Independent Consulting Engineers (ICE), with headquarters on the Dutch side, indicated that there were significant differences in the regulatory regimes on the two sides of the border. ICE maintained offices in both territories. On the Dutch side the buildings were designed in accordance with a variety of standards, including those of the Netherlands. The checking authority was the government Public Works Department, although this task was occasionally contracted out to private firms. On the French side construction had to comply with the French “norms” and the design and construction were checked by *bureaux de contrôle*. In Mr Daal’s words, on the French side “you have to do it right”.

During Gibbs’ visit the Contractors Association in Sint Maarten arranged an evening forum of architects, engineers, builders and government officials which he addressed on the subject of “Hurricanes and Their Effects on Buildings and Other Structures”. After the lecture there was a wide-ranging discussion on various issues related to the Luis experience in Sint Maarten and the way forward for the building industry. Again, the contrast with French Sint Martin was alluded to. The differences outlined by those familiar with construction on both sides of the border included:

- better attention to conceptual design on the French side;
- greater consistency and uniformity of standards of design for earthquakes and hurricanes on the French side;
- the involvement of *bureaux de contrôle* on the French side.

3 *Bureaux de Contrôle*

The *bureaux de contrôle* are independent firms licensed by the state. They pay well and attract, and keep, some of the best talent. They check designs and also make site visits during construction. Their involvement in projects is necessary if decennial (10-year) insurance cover is to be obtained by the building owner. Lending agencies also demand the certification of *bureaux de contrôle*.

Because of the above observations in Sint Maarten / Saint Martin the Pan American Health Organisation Emergency Preparedness & Disaster Relief Coordination Programme office in Barbados assisted in sending Gibbs to Martinique in June 1996 to investigate the French system of controlling building standards. A considerable amount was learned during a two-day visit. It is useful to summarise the main information gathered during that visit.

During the visit, meetings were held with representatives of the government, architects, engineers, small builders, large contractors, developers, property managers and *bureaux de contrôle*. The most remarkable result of the various discussions was that Gibbs could not find any group who disagreed with the system of using *bureaux de contrôle* to review the design and construction of buildings. Most comments were positively favourable. The *bureaux de contrôle* were seen as being generally helpful and as having a developmental role in the construction industry.

There were five *bureaux de contrôle* operating in Martinique at that time. That provided clients with choices and provided some market-driven restraint over the cost of these services. The building owners pay the *bureaux de contrôle*. Thus, in effect, a building owner would employ two sets of consultants on each project - the design team and the *bureaux de contrôle*.

There were some inconsistencies in the answers Gibbs received in seeking to find out the area of applicability of use of *bureaux de contrôle*. It appeared that a law of 1978 required building owners to purchase decennial insurance for all new properties. The insurance providers required the certification of *bureaux de contrôle* before writing policies. But how widespread was this? Some persons indicated that all new buildings required *bureaux de contrôle*. Others said that all new buildings using borrowed funds for construction required *bureaux de contrôle*. Others said that all new buildings where the public had access required *bureaux de contrôle*. Suffice it to say that the use of *bureaux de contrôle* in Martinique, and other parts of France, was (and still is) widespread and its beneficial effect on Saint Martin was manifest.

But how do others see the role of *bureaux de contrôle*? Here are two quotations from Peter Rice's²⁰ book "The Engineer Imagines":

"It is no accident of time that both the La Villette and IBM projects first appeared in France where there exist the most intelligent and knowledgeable checking authorities that I have come across. The large centralized controlling offices, *bureaux de contrôle*, Socotec, Veritas, CEP²¹ and others each have at their head engineers who are equal in ability to any I have encountered in the best design offices, as Centre Pompidou amply demonstrated." - page 113

"Others not so closely involved must also be asked to review the project to question the assumptions and demand explanations... The presence of a competent, dedicated and sceptical checking authority is also very important in this respect." - page 123

4 Recommendations

The French approach described above is worthy of adoption on a wider scale. Nevertheless, recognising the relative infrequency of the practice in the wider Caribbean, it would be desirable to explain more carefully to funding agencies, clients and design consultants the purposes of independent reviews.

²⁰ Peter Rice:
Born in Ireland in 1935. Died in 1992
Queen's Univ of Belfast, Imperial College of S, T & M (London), Cornell University
With Ove Arup & Partners:

- Sydney Opera House (with Utson)
- Lightweight roof structures (with Otto)
- Centre Pompidou (with Piano & Rogers)
- Pabellon del Futuro (Expo 1992, Sevilla)
- Charles de Gaulle Aerogare 3 (Paris)
- Kansai Airport Terminal Building (Japan)

Young, gifted, dedicated engineering designer with unique qualities
Honorary Fellow and Royal Gold Medallist (RIBA)

²¹The French firm *Contrôle et Prevention*.

The prime role of a review consultant is to reduce the incidence of errors or unsatisfactory designs and construction. However, the role of a review consultant is not simply (or mainly) that of a policeman. In countries (such as the French Antilles) the review consultant, *bureau de contrôle*, is seen as being generally helpful and as having a developmental role in the construction industry.

It is accepted that to err is human. This is inferred in the words of the late design engineer Peter Rice quoted at the end of section 3 of this Appendix. It is not so much a question of one engineer checking on another. It is more a question of a review consultant assisting a design consultant in achieving a better and more reliable project by providing independent assessments of the work.

Obviously, there will be cases where deliberate sub-standard work and sheer incompetence are present. In such cases the involvement of a review consultant would be vital for the fundamental well being of the project, for the protection of the client and in providing security for the funding agency and insurance underwriter.

To achieve better results from this process of independent design reviews in the Caribbean, the following actions should be taken:

- Hold discussions between the client, the funding agency and other relevant parties at the initiation of the project to examine the intentions of the exercise and to determine the scope of the service.
- Provide the prospective design consultants with the terms of reference of the review consultant as part of the description of the project for which they are proposing their services.
- Hold discussions between the selected design consultant and the review consultant at the start of the assignment of the design consultant. These discussions would be the opportunity to agree on detailed timetables for submissions and reviews and on *modi operandi*.
- Do not involve the client in a blow-by-blow account of review discussions, but limit formal reports to final conclusions of the reviews. (This would need to be dispensed with if an impasse is reached between the designer and the reviewer.)

The above recommendations are by no means a “book of words” for independent reviews. Such books of words probably exist. Several different systems are present. Those known (in a general sense) to Tony Gibbs are the systems in France, the United Kingdom, Germany, Japan, Mexico City, Colombia, California and Vancouver (Canada). Some of these systems were discussed and debated at the “Winds of Change” seminar as part of the present DIPECHO-III project in order to assist in the development of an approach suited to the needs of the Caribbean.

It should be added that (at least) all critical facilities and post-disaster assets in the Caribbean have, in the future, the involvement of check consultants in addition to the conventional design teams for capital works projects, including additions to existing buildings and major renovations.

5 Consequences of Introducing the System of Check Consultants

With the introduction of an effective method of enforcement of standards one can expect:

- better information on the hazards;
- improved standards documents;
- more appropriate conceptual designs, leading to lower construction costs;
- improved quality of tertiary education for architects and engineers;
- better organised post-graduation formation of professionals;
- self-financing continuing professional development programmes.

6 Conclusion

There is a convincing case for peer reviews as a means of reducing the incidence of failures of Caribbean healthcare facilities and other infrastructure, especially as a result of natural hazards. "Peer" reviews because the system can only work where the reviewer is at least as knowledgeable and experienced as the designer. Obviously the system works best where the reviewer is more knowledgeable and experienced than the designer. In such circumstances there is a real opportunity for the development of the profession and the development of the whole industry.

APPENDIX A-V

DETAILED ENGINEERING

CHECK LIST FOR DESIGNING TO COUNTERACT NATURAL HAZARDS (Earthquakes, Hurricanes and Torrential Rains)

Appendix V constitutes a comprehensive list of issues to be addressed in designing to counteract the effects of natural hazards. This is a very complex process, if done properly and thoroughly. Thus, check lists are invaluable to the exercise. For any particular project all of the items may not be relevant, but excluding items from a comprehensive list is always easier than adding relevant items to a short list.

1 Seismic, Hurricane and Rain Hazards

- 1.1 History
 - 1.1.1 Earthquake
 - 1.1.2 Hurricane
 - 1.1.3 Torrential rain
- 1.2 Geology
- 1.3 Tectonics
- 1.4 Design characteristics
 - 1.4.1 Earthquake design characteristics
 - 1.4.2 Hurricane design characteristics
 - 1.4.3 Design characteristics for torrential rains

2 Site Conditions

- 2.1 Soils
 - 2.1.1 Liquefaction
 - 2.1.2 Seismic characteristics
- 2.2 Topography
 - 2.2.1 Landslide
 - 2.2.2 Building on slopes
 - 2.2.3 Topographic effect on wind speeds
 - 2.2.3.1 Ridges
 - 2.2.3.2 Valleys
 - 2.2.4 Flood prone areas
 - 2.2.4.1 Torrential rains
 - 2.2.4.2 Storm surge
 - 2.2.4.3 Tsunami
- 2.3 Other Factors
 - 2.3.1 Corrosive Environments
 - 2.3.1.1 Coastal areas
 - 2.3.1.2 Industrial and other chemical pollutants

3 The Client's Brief

3.1 Function

3.2 Cost

3.3 Reliability

3.3.1 Serviceability for different components of the facility

3.3.2 Safety for different components of the facility

4 Design Philosophy

4.1 Performance in moderate and frequent hazardous events

4.1.1 Protection of property

4.1.1.1 Cost of repairs should be minor

4.2 Performance in strong, rare, hazardous events

4.2.1 Saving lives

4.2.2 Repairable damage (very critical facilities in earthquake events)

4.2.3 Protection of all property in hurricanes and torrential rains

4.2.4 Protection of all property in earthquakes (base isolation)

4.3 Critical areas or components of facilities

4.4 Post-yield behaviour of structural elements

4.4.1 Ductility

4.4.2 Energy absorption

4.4.3 Deformations

4.5 Building Envelope for Hurricanes

4.5.1 Windows, external doors and roof cladding

5 Choice of Form or Configuration

Poor design concepts can be made safe but are unlikely to perform really well in strong earthquakes

5.1 Failure modes

5.1.1 Redundancy

5.1.2 Accidental strength

5.1.3 Column capacities (and those of other vertical load-carrying elements) -
New Zealand's "capacity design"

5.1.4 Designing for failure

5.1.4.1 Avoid failure in vertical, shear and compression elements

5.1.4.2 Avoid brittle failure

5.1.4.3 Avoid buckling failure

5.1.5 For hurricane forces design for repeated loads without degradation

5.2 Geometric issues

5.2.1 Simplicity and symmetry

- 5.2.2 Long buildings to be structurally broken (separation gaps of sufficient widths to avoid hammering in earthquakes)
- 5.2.3 Elevation shape
 - 5.2.3.1 Sudden steps and setbacks to be avoided
- 5.2.4 Uniformity
 - 5.2.4.1 Distribution of structural elements
 - 5.2.4.2 Principal members to be regular
 - 5.2.4.3 Openings in principal members to be avoided
- 5.2.5 Continuity
 - 5.2.5.1 Columns and walls from roof to foundation (without offsets)
 - 5.2.5.2 Beams free of offsets
 - 5.2.5.3 Coaxial columns and beams
 - 5.2.5.4 Similar widths for columns and beams
 - 5.2.5.5 Monolithic construction
- 5.2.6 Stiffness and slenderness ($h > 4b$)
 - 5.2.6.1 Stiffness versus flexibility
 - 5.2.6.2 Maintaining the functioning of equipment
 - 5.2.6.3 Protecting structure, cladding, partitions, services
 - 5.2.6.4 Resonance
- 5.2.7 Favourable and unfavourable shapes
 - 5.2.7.1 Square
 - 5.2.7.2 Round and regular polygons
 - 5.2.7.3 Rectangular
 - 5.2.7.3.1 Aspect ratios
 - 5.2.7.4 T and U shaped buildings
 - 5.2.7.4.1 Aspect ratios
 - 5.2.7.4.2 Deep re-entrant angles
 - 5.2.7.4.3 Establish structural breaks (create rectangular plan forms - see 5.2.2)
 - 5.2.7.5 H and Y shaped buildings
 - 5.2.7.5.1 Aspect ratios
 - 5.2.7.5.2 Deep re-entrant angles
 - 5.2.7.5.3 Establish structural breaks (create rectangular plan forms - see 5.2.2)
 - 5.2.7.6 External access stairs
 - 5.2.7.7 False symmetry - regular perimeter masking irregular positioning of internal elements
- 5.2.8 Soft storey
- 5.2.9 Cantilevers to be designed conservatively
- 5.2.10 Desirable roof shapes for hurricane resistance
 - 5.2.10.1 Steep pitched roofs (20 - 40 degrees)
 - 5.2.10.2 Hipped roofs are preferable
 - 5.2.10.3 Gable roofs are an acceptable compromise
 - 5.2.10.4 Mono-pitched roofs are undesirable
 - 5.2.10.5 Boxed eaves recommended for overhangs exceeding 450mm
 - 5.2.10.6 Parapets reduce wind uplift
 - 5.2.10.7 Ridge ventilators reduce internal pressures
- 5.3 Distribution of horizontal load-carrying functions in proportion to vertical load-carrying functions (avoid the overturning problem)

- 5.4 Structural system to be agreed by design team
 - 5.4.1 Moment-resisting frames
 - 5.4.2 Framed tubes
 - 5.4.3 Shear walls and braced frames
 - 5.4.4 Mixed systems

- 6 Choice of Materials**

- 6.1 Local availability
- 6.2 Local construction skills
- 6.3 Costs
- 6.4 Politics
- 6.5 Ideal properties
 - 6.5.1 High ductility
 - 6.5.2 High strength-to-weight ratio
 - 6.5.3 Homogeneous
 - 6.5.4 Ease of making connections
 - 6.5.5 Durable
- 6.6 Order of preference for low-rise buildings
 - 6.6.1 In-situ reinforced concrete
 - 6.6.2 Steel
 - 6.6.3 Reinforced masonry
 - 6.6.4 Timber
 - 6.6.5 Prestressed concrete
 - 6.6.6 Precast concrete
 - 6.6.7 Unreinforced masonry not recommended
- 6.7 Light-weight roof cladding of pitched roofs
 - 6.7.1 Method of fixing critical to roof performance

- 7 Construction Considerations**

- 7.1 Supervision
- 7.2 Workmanship
- 7.3 Ease of construction

- 8 Components**

- 8.1 Base isolators and energy-absorbing devices (to be given consideration)
- 8.2 Foundations
 - 8.2.1 Continuous

- 8.2.2 Isolated (to be avoided)
- 8.2.3 Piled
- 8.3 Movement and separation joints
- 8.4 Diaphragms
- 8.5 Precast concrete
- 8.6 Welded beam-column joints for moment-resisting steel frames (to be avoided)
- 8.7 Shear walls and cross bracing
- 8.8 Hurricane straps, wall plates and connections
- 8.9 Joint details for roof trusses
- 8.10 Asbestos-cement cladding (unfavourable in hurricane situations)
- 9 Elements**
- 9.1 Structure
- 9.2 Architecture
- 9.3 Equipment
 - 9.3.1 Electrical feed to be kept clear of roof structure
 - 9.3.2 Electrical feed to be routed underground within the property
- 9.4 Contents
- 10 Cost Considerations**
- 10.1 Capital costs ignoring natural hazards (hypothetical, academic)
- 10.2 Capital costs including natural hazards
- 10.3 Maintenance costs
- 11 Analysis**
- 11.1 Understanding the structural model
- 11.2 Torsional effects
- 11.3 Geometric changes
 - 11.3.1 The P-delta effect
- 11.4 3-D analysis (required only for irregular structures)

- 11.5 Dynamic analysis (required only for complex structures)
- 11.6 Stress concentrations
- 11.7 Complexity of earthquake effects and inadequacies of sophisticated analytical methods
- 11.8 Effects of non-structural elements
 - 11.8.1 Change in the natural period of the overall structure
 - 11.8.2 Redistribution of lateral stiffness and, therefore, forces and stresses (this could lead to premature shear or pounding failures of the main structures and also to excessive damage to the said non-structural elements due to shear or pounding)
- 11.9 Soil-structure interaction
 - 11.9.1 Critical but usually ignored or played down
- 12 Detailing**
- 12.1 Compression members
- 12.2 Beam-column joints
 - 12.2.1 Reinforced concrete
 - 12.2.2 Structural steel :- all-welded construction
- 12.3 Reinforced-concrete frames
- 12.4 Non-structural walls and partitions
- 12.5 Shelving
- 12.6 Mechanical and electrical plant and equipment
 - 12.6.1 Securely fastened to the structure
 - 12.6.2 Pipework
- 13 Construction Quality**
- 14 Maintenance**
- 14.1 Refer to Appendix A-XI – “Maintenance as a Tool for Mitigation”

APPENDIX A-VI

BASE ISOLATION FOR BUILDINGS

This Appendix relies to a significant extent on the work of the *Association Française du Génie Parasismique* as presented in its document *Guide AFPS*. The figures are taken from that document.

1 Notion of Base Isolation

Seismic damage to buildings is caused by deformation which occurs when the superstructure oscillates (fig 1). These oscillations, occurring as each seismic wave passes, are put in motion by the ground to which the buildings are mechanically attached at their foundations.

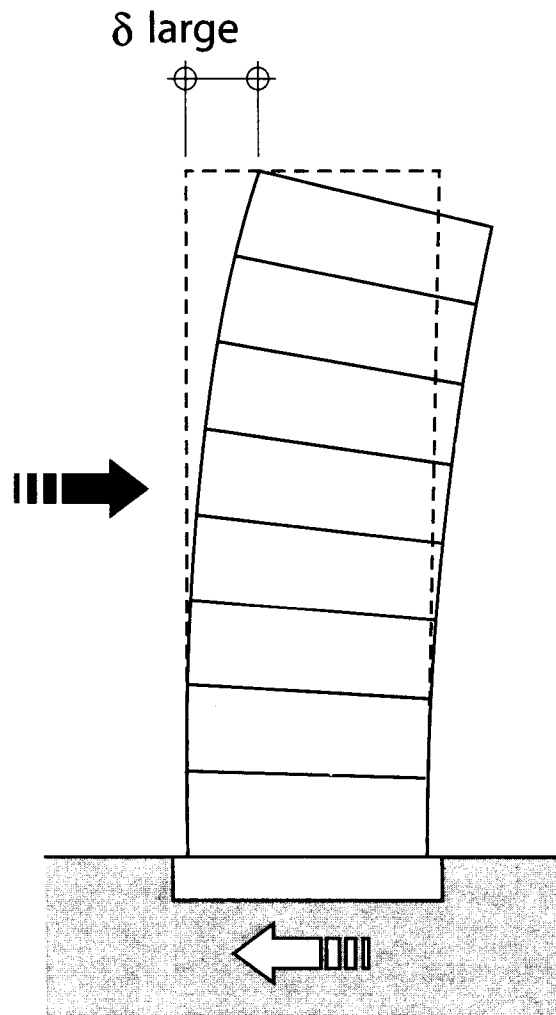

Figure Ap1 - Large Oscillation of Structure Without Base Isolators

One effective way of protecting buildings from earthquakes consists of isolating them from the oscillations of the ground. This isolation cannot be total, but it often allows the seismic action to be reduced by a factor of 5 to 6, thus reducing significantly damage to buildings and equipment.

What is being considered here is a strategy for the protection of facilities different from the traditional approach proposed in most earthquake-resistant standards and codes.

- Most earthquake-resistant standards and codes aim at saving human lives first and foremost, even at the cost of some structural damage (whether that damage can be repaired or not) and depending on the intensity of the earthquake. Such a building may even need to be demolished after a particularly severe earthquake.
- Base isolation aims at not only ensuring the building occupants' safety, but also reducing serious damage to the structure, to the non-structural building components and to equipment. A base-isolated building is therefore supposed to be operational immediately after an earthquake. This goal should be required for hospitals, fire stations, decision-making headquarters or other strategic buildings in an emergency situation.

2 The Principle of Base Isolation

The isolation of buildings is carried out by means of support mechanisms whose horizontal stiffness is much less than that of the structure. These mechanisms, called "base isolators", are placed between the foundations and the superstructure or between the basement and the ground floor or between the ground floor and the first floor (fig 2). Regular inspection of the supports must be scheduled and the possible replacement of these supports must be planned for.

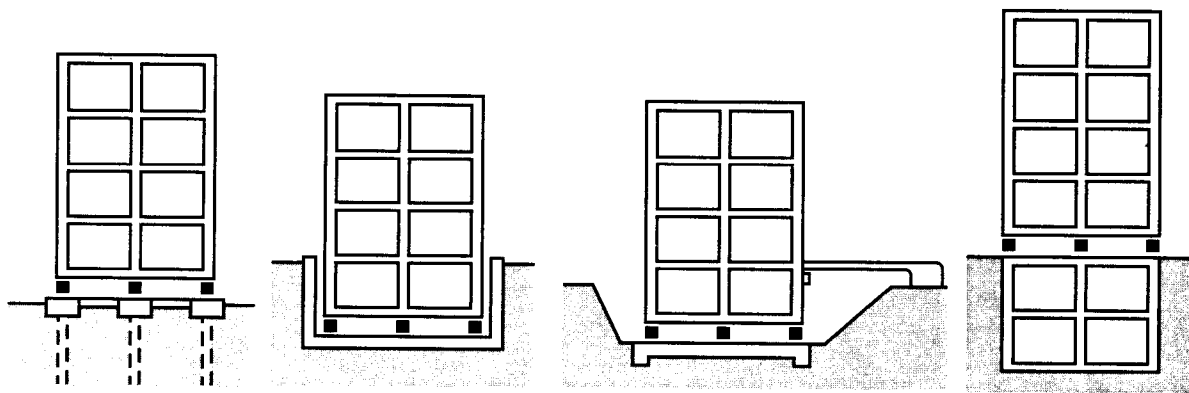

Figure Ap2 - Different Positions for Base Isolators

The base isolators allow for relative horizontal displacement between the superstructure and the firm ground, thus separating their oscillations. Vertically, the base isolators have to be rigid to prevent swaying, which would be unacceptable.

The displacements transmitted to the building by the ground motions are concentrated principally around the base isolators, which are designed to withstand them without sustaining damage (fig 3 and 4). The seismic actions are reduced through these displacements as the base isolators act as shock absorbers.

The superstructure should be rigid enough to move on the supports like an almost undeformed block (fig 3). It is this behaviour which reduces damage.

On the other hand, the foundations must be firm enough for the base isolators not to experience significant differential vertical movement.

It is to be noted that the design of base isolators and base-isolated buildings has to involve the use of specialists, because the procedure is not part of the common knowledge and experience of structural engineers.

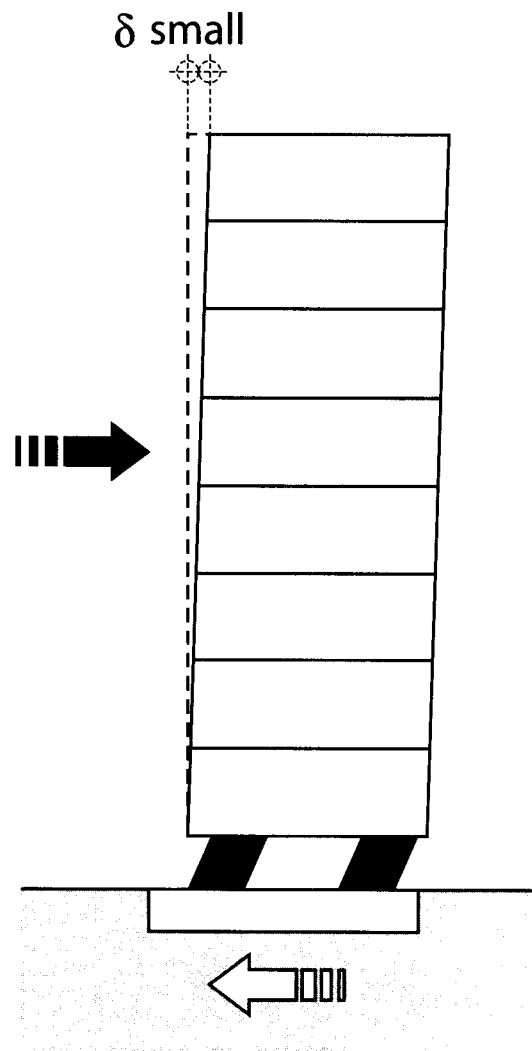

Figure Ap3 - **Small Oscillation of Structure With Base Isolators**

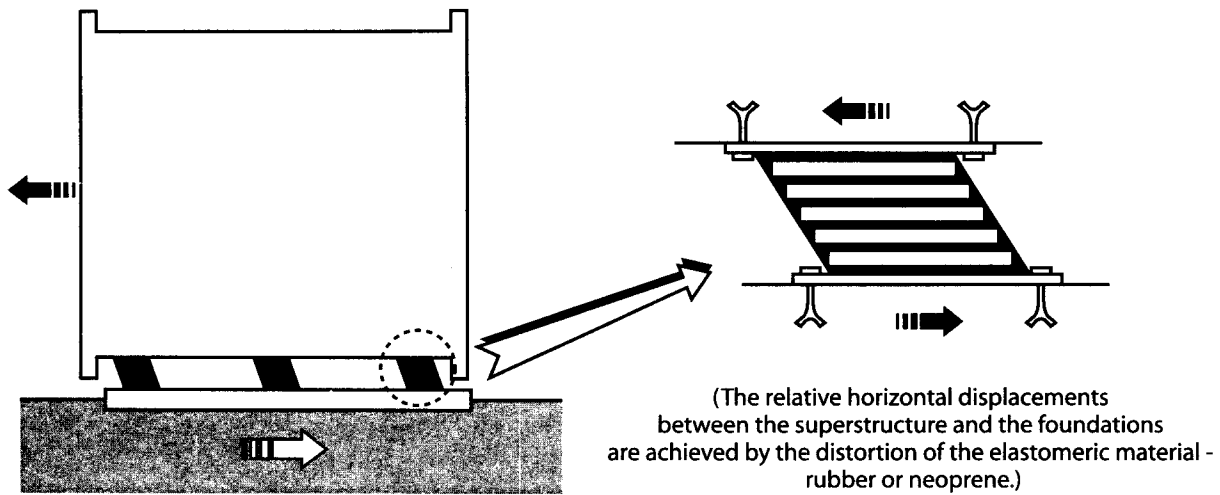

Figure Ap4 - Isolators Made of Banded Elastomeric Material

3 Types of Support

Several types of support exist. Two are commonly used at present:

- Supports of banded elastomeric material (rubber or neoprene): The horizontal displacements required are obtained by the distortion of the elastomeric material (fig 4).
- Sliding supports: The sliding is brought about at the interface of two plates (fig 5a) or inside a support mechanism with a concave sliding surface (fig 5b).

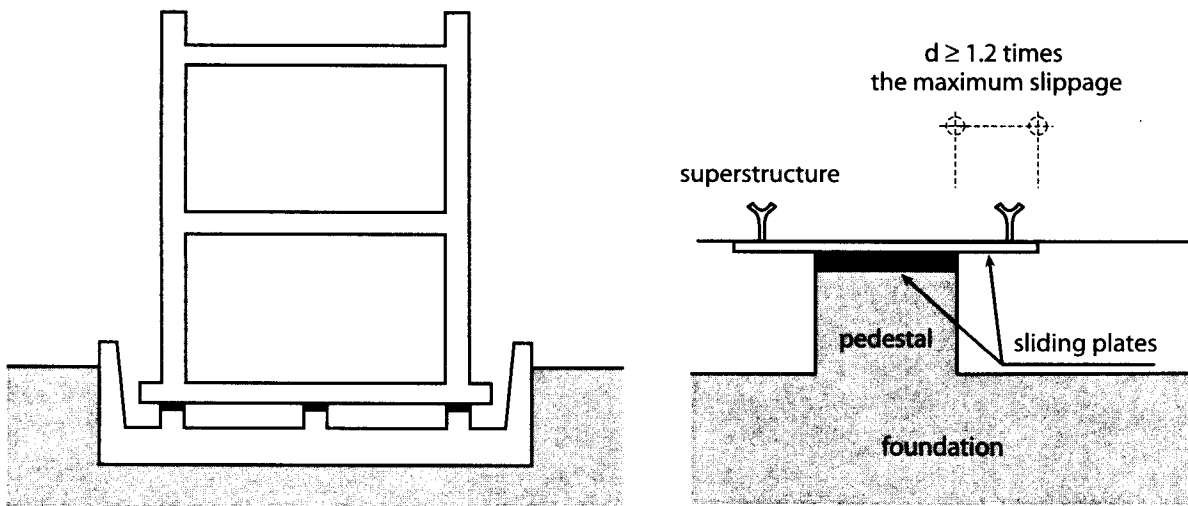

Figure Ap5a - Sliding plates:

In order to avoid the formation of an indentation in event of infrequent sliding, the upper plate should be harder than the lower one.

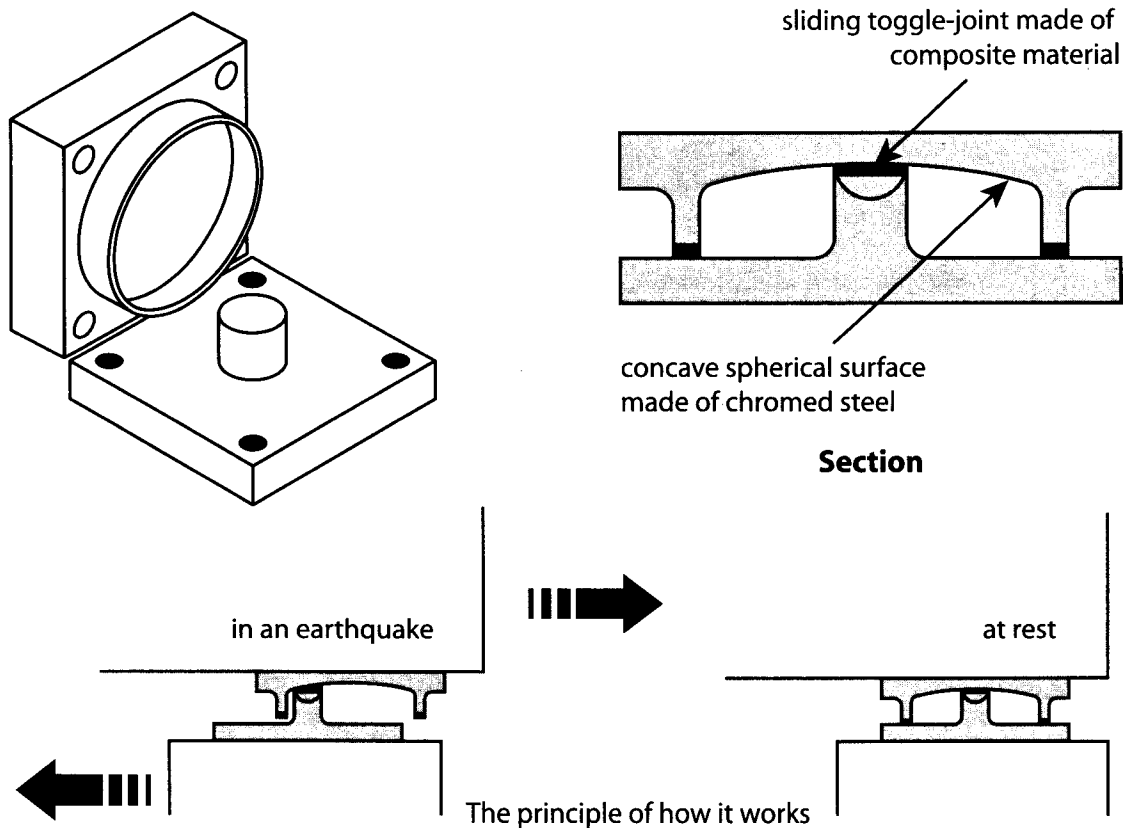

Figure AP5b - Mechanism With Concave Sliding Surfaces

4 Advantages and Disadvantages of Base Isolation

4.1 Advantages

- The level of protection obtainable is higher than the level demanded in traditional standards and codes. Buildings normally remain operational even after severe earthquakes whereas the functioning of non-isolated buildings is unreliable at best. The damage to non-structural building components and equipment, which often represent a considerable investment (especially in the case of hospitals), is negligible or non-existent.
- The reduction of seismic action makes easier the theoretical elastic analysis of the structure. This calculation is more reliable than the analysis of buildings likely to undergo inelastic deformation.
- Since the structure is elastic, ie without permanent deformations, the progressive degrading of the building due to several earthquake events is avoided.
- The base isolators normally remain intact after an earthquake and function again in subsequent shocks (eg after-shocks).
- The disadvantages connected with the asymmetrical shape of buildings or the complexity of their form or structure can be limited, because the behaviour of a building on isolators depends mainly on the distribution of the stiffness of these isolators and much less on the distribution of the stiffness of the building structure.

4.2 Disadvantages

- All the services crossing the level of the supports (elevators, staircases, pipes, conduits, *etc*) or joining the building with its immediate surroundings (road/telephone/electricity networks, external steps, *etc*) have to be designed so as to tolerate without damage the relative displacement of the superstructure and the foundations. These measures are particularly important when designing the infrastructure for gas, fire protection and waste-disposal.
- The possible separation joints between two buildings or parts of a building on isolators need significant width because of the combined displacements of the individual blocks.
- Future changes to the structure, the partitions, façades and other heavy or stiff components should not significantly change the building's original dynamic behaviour which would have been taken into consideration for determining the dimensions of the base isolators, unless the owners and their building professionals wish to be involved with high adaptation costs.

5 Effect on the Cost of the Building

Base isolation generally increases the original capital cost of the building, but it offers better protection than the traditional design approaches. However, in the case of taller buildings (say six or more stories), it can be less expensive than traditional designs. Moreover, if the relative performance of the two approaches is considered, buildings with isolation are overall more economical than those relying on classic methods for protection.

An important life-cycle cost consideration is the expense of catastrophe insurance. This should sensibly be far lower than for conventionally-designed buildings.

APPENDIX A-VII

DESIGN OF NEW BUILDINGS CONSIDERING THE EXPLOSION HAZARD

This Appendix relies to a significant extent on the work of a committee set up by The Institution of Structural Engineers (see section 5).

1 General

At present it is unlikely that public healthcare facilities will be required to be designed and constructed consciously to resist deliberate bombing by terrorists. On the other hand gas explosions are more likely occurrences and there should be some consideration given to these accidental events in the design of new facilities. In the case where the hospital owner requires deliberate measures to take account of terrorist threats, the design team should consult with the owner to determine the level of protection required for the facility.

What will be discussed here are not bomb proof buildings but facilities which will protect the lives of those remote from the hypocentre of the explosion and limit the damage to the structure. Where the threat is clearly identified and could reasonably be anticipated specialist expertise should be sought.

It is possible to build into a normal structure measures which will enhance its performance in the event of an accidental or even a deliberate explosion. When the building is located in a high seismic zone the additional effort and cost of providing such enhanced performance is moderate. What will be discussed are conceptual approaches to reducing the amount of damage to buildings and injury to persons in the event of explosions. It must be accepted, however, that the protection provided by these approaches is relative and not absolute.

2 Conceptual Design

This is usually the domain of the architect. However, in this as in the cases of earthquake resistance and hurricane resistance, the architect would be well advised to seek the early assistance of the structural engineer on the design team. Since the implications of planning for explosions can be far-reaching, the involvement of the owner is also critical at this early stage of the project.

Since distance from the hypocentre of an explosion is generally inversely proportional to potential damage, setting the buildings back from uncontrolled areas would be a very important planning strategy. This, of course, relates to deliberate terrorist activity and not to accidental events caused by the malfunctioning of plant and equipment in the hospital itself. In the case of healthcare facilities in congested urban environments, it would be difficult to set back the structures to any significant extent from public roads. The judicious locating of bollards as well as hard and soft landscaping could help in such circumstances. Vehicular access and car-parking through and under buildings should be avoided.

It has to be said that live and electronic controls would play significant roles in preventing deliberate explosive attacks so that these control functions should be planned for at the conceptual stage of projects. The issue of providing for better human and electronic surveillance should be addressed early on in respect of:

- the entrance to the building which should be controlled;
- the internal arrangement of the building, both functional and physical (fewer columns and other obstructions in public spaces);
- the separation of public spaces from other areas by robust construction for greater physical protection, and the general compartmentalising of the overall facility.

The shape of a building is important. As in the case of earthquake-resistant design, complex shapes are unfavourable. In the case of explosions, such shapes may lead to multiple reflections of the blast wave. Projecting roofs and floors, and buildings that are U-shaped on plan are undesirable for this reason. Fortunately for the designer in an environment with multiple natural hazards these are characteristics which already raise red flags without the presence of explosion threats.

3 Structural Considerations

The most favourable performance in the event of explosions will be achieved by using insitu reinforced concrete structures. Steel framed structures with insitu concrete floors also perform well. These systems have the following characteristics:

- “accidental” strength over and above the essential structure envisaged by the designer;
- substantial ductility in the case of well-designed earthquake-resistant structures capable of absorbing large amounts of energy through plastic deformation before they fail;
- inherent redundancy so that the failure of one member does not lead to progressive collapse (This was envisaged by the Fifth Amendment²² to the London building regulations which was introduced following the Ronan Point²³ disaster);
- relatively heavy structures providing more inertial resistance to shock loads;
- interconnection of all structural elements in the case of insitu reinforced concrete and most structural components in the case of structural steel frames with insitu reinforced concrete slabs.

In those parts of the Caribbean where wind loads are dominant and the earthquake hazard is negligible more deliberate steps would have to be taken to provide the required degree of resistance to explosions because of:

- the less stringent requirements for beam-to-column connections;
- lower ductility requirements;
- the lesser ability of the structure to resist load reversals;

²²The Fifth Amendment requires a building structure to be analysed and detailed so that any single column at any level could be removed without leading to the collapse of the building. This criterion was adopted for the design of British High Commission chancery buildings in the Caribbean.

²³Ronan Point was a multi-storey, residential block south of London which suffered progressive collapse as a result of an accidental gas explosion in 1969. (Curiously, this was the catalyst for the rewriting of the UK wind-loading standard.)

when compared with structures well-designed to resist significant earthquake loading. In such cases these weaknesses should be addressed deliberately.

Beam-to-column connections, particularly those on the perimeter of a building, require greater strength and ductility to cater for the horizontal component of the blast forces and the vertical component from the differential loading on floor slabs.

Blast loading is dynamic in nature. So are wind loads and earthquake loads. Proper detailing for multi-hazard design (as required in most Caribbean countries) would go a long way in providing a considerable degree of enhanced security in the event of accidental explosions and nearby deliberate explosions. It was noted that the Oklahoma bombing would not have caused a disaster had the building been designed for the contemporary requirements of Los Angeles or similar high seismic hazard areas in the USA.

Some of the desirable features in the detailing of beam-column joints are:

- the use of extra links (otherwise required for earthquake resistance);
- judicious location of the starter bars;
- anchorage of reinforcement outside the beam-column panel zone;
- steelwork connections providing for load reversals (also present in earthquakes).

Since blast loading can be in any direction (again akin to earthquake loading) it would be desirable to have:

- continuous top steel in reinforced concrete slabs;
- effective connections between beams and slabs;
- lateral restraint to the bottom flanges of steel beams;
- additional ties or bolts between beams and perimeter columns;
- moment-resisting connections between beams and columns.

None of these characteristics are unknown to those experienced and up-to-date in the principles of earthquake-resistant design and detailing.

The concrete encasing of perimeter steel beams and stanchions is desirable to:

- provide a near monolithic connection of perimeter cladding;
- provide better fire resistance to the structure;
- provide increased strength and stability of the perimeter steelwork over and above the calculated strength at the design stage;
- to improve the continuity at beam-column connections.

These features will come into play in the event of an explosion.

If precast concrete slabs are preferred for a particular project, their use should be restricted to upper floors (above the first suspended floor). Other cautionary actions would include:

- tying the precast elements securely to their supporting beams;
- employing a reinforced concrete topping with reinforcement in both directions.

With composite construction using profiled sheets, cautionary actions would include:

- fixing of floor slabs to beams with shear connectors;
- thickening the concrete topping.

Avoid lightweight roofs structures and never incorporate glass roofs in the design.

4 Windows and Cladding

Broken glass poses a hazard to occupants of the building as well as to passers by. Windows with plain annealed glass fail at relatively low blast loads and should be avoided. Great care and attention should be devoted to the design of windows in the face of explosion threats. Fortunately this is also the case in hurricane situations and increasingly so in earthquake situations. The designers of hospitals in multi-hazard areas such as most of the Caribbean now have three reasons to pay greater attention to the design of windows.

Laminated glass provides the best answer for the three hazards (explosion, earthquake and wind). In this respect, attention must also be devoted to the frames supporting the glazing elements. After the pane of laminated glass has cracked (as it probably will) it will not fall apart and it will continue to function as a barrier to the outside provided it is held securely in a strong and deeply-rebated window frame with structural silicone. The laminate, polyvinyl butyral (pvb), provides resistance by developing membrane action.

Typically, laminated glass consists of one layer of pvb between two layers of glass. Thicknesses vary depending on the design criteria but, for explosion-resistant purposes the minimum overall thickness should be 7.5mm (1.5mm thick pvb interlayer sandwiched between two sheets of 3mm glass). Double-glazed windows should have the inner pane laminated for blast resistance. This is at odds with the desired situation for impact-resistance in a hurricane. As in so many other aspects of buildings a choice or compromise must be made. The non-laminated pane in double glazing should preferably be of toughened glass.

As in the case of hurricane-resistant design the window frames should be designed to resist both the inward and outward forces. The hinges and locking devices must be of commensurate strength and the fixings of the frames to the building structure must be capable of resisting the loading from the glazing system. This is very much a case of a chain being as weak as its weakest link.

An alternative to using laminated glass in special frames is to provide polycarbonate glazing.

The use of anti-shatter film applied to the inside of ordinary glazing is not recommended because:

- it is less effective than installing laminated glass in special frames;
- the film can be easily damaged;
- the film has a limited life expectancy.

In view of these considerations, this strategy is not recommended for new work, although it could be considered for the improvement of existing buildings.

The cladding of a building is also likely to suffer damage from an external explosion, especially if it is of the lightweight variety. Masonry walls are substantially better for this purpose.

The use of precast concrete panels as external cladding provides adequate protection in the event of explosions only if they are reinforced and have adequate fixings to resist rebound forces. Panel fixings should also exhibit the property of ductility. Flexible cleats are preferable to cleats with stiffeners and resilient washers can be used to achieve a similar effect. Provision should be made for examining the fixing system after an explosion so that any failure can be detected.

5 Reference

“The Structural Engineer's Response to Explosion Damage” - published for The Institution of Structural Engineers, London, England, November 1995

APPENDIX A-VIII

EARTHQUAKES

CHECK LIST FOR NON-STRUCTURAL COMPONENTS FOR EARTHQUAKES

This Appendix constitutes a list of items and issues to be considered in designing the non-structural components of healthcare facilities to counteract the effects of earthquakes. Check lists are valuable as *aides-mémoire* for the exercise. For any particular project all of the items may not be relevant, but excluding items from a comprehensive list is always easier than adding relevant items to a short list.

- 1 **Electricity**
 - 1.1 Generator
 - 1.1.1 Anchorage of the emergency generator
 - 1.2 Batteries
 - 1.2.1 Attachment of the batteries to the battery rack
 - 1.2.2 Cross-bracing the rack in both directions
 - 1.2.3 Battery rack bolted securely to a concrete pad
 - 1.3 Diesel Fuel Tank
 - 1.3.1 Attachment of the tank to the supports
 - 1.3.2 Cross-bracing the tank supports in both directions
 - 1.3.3 Bracing attached with anchor bolts to a concrete pad
 - 1.4 Fuel Lines and Other Pipes
 - 1.4.1 Lines and pipes attached with flexible connections
 - 1.4.2 Able to accommodate relative movement across joints
 - 1.5 Transformers, Controls, Switchgear
 - 1.5.1 Items properly attached to the floor or wall
 - 1.6 Bus Ducts and Cables
 - 1.6.1 Able to distort at their connections to equipment without rupture
 - 1.6.2 Able to accommodate relative movement across joints
 - 1.6.3 Laterally braced
- 2 **Fire Fighting**
 - 2.1 Smoke Detectors and Alarms
 - 2.1.1 Properly mounted
 - 2.1.2 Control system and fire doors securely anchored
 - 2.2 Fire Extinguishers and Hose-reel Cabinets
 - 2.2.1 Cabinets securely mounted
 - 2.2.2 Extinguishers secured with quick-release straps

- 2.3 Emergency Water Tank
 - 2.3.1 Securely anchored to its supports
 - 2.3.2 Supports braced in both directions
 - 2.3.3 Supports or braces anchored to a concrete foundation

- 3 **Propane Tanks**

- 3.1 The Tank
 - 3.1.1 Securely anchored to its supports
 - 3.1.2 Supports braced in both directions
 - 3.1.3 Supports or braces anchored to a concrete foundation

- 3.2 Shut-off Valve
 - 3.2.1 System with an automatic, earthquake-triggered, shut-off valve
 - 3.2.2 If manual, provided with a wrench stored close by

- 3.3 Supply Pipes
 - 3.3.1 Able to accommodate relative movement across joints and at the tank
 - 3.3.2 Laterally braced

- 4 **Plumbing**

- 4.1 Water Heaters and Boilers
 - 4.1.1 Securely anchored to the floor or wall
 - 4.1.2 Gas line with a flexible connection to the heater or boiler to accommodate movement

- 4.2 Pumps
 - 4.2.1 Anchored or mounted on vibration isolation springs with seismic lateral restraints

- 4.3 Hot and Cold-water Pipes and Wastewater Pipes
 - 4.3.1 Pipes laterally braced at reasonable intervals
 - 4.3.2 Flexible connections to boilers and tanks
 - 4.3.3 Able to accommodate movement across joints
 - 4.3.4 Pipe penetrations through walls large enough for seismic movement
 - 4.3.5 Free of asbestos insulation (which can be broken in an earthquake)

- 4.4 Solar Panels
 - 4.4.1 Securely anchored to the roof

- 5 **Elevators**

- 5.1 Cab
 - 5.1.1 Properly attached to the guide rails
 - 5.1.2 Alarm system for emergencies

- 5.2 Cables, Counterweights, Rails
 - 5.2.1 Cables protected against misalignment during an earthquake

- 5.2.2 Counterweights properly attached to guide rails
- 5.2.3 Guide rails properly attached to the building structure
- 5.3 Motors and Control Cabinets
 - 5.3.1 Anchored
- 6 Air Conditioning**
- 6.1 Chillers, Fans, Blowers, Filters, Air Compressors
 - 6.1.1 Anchored, or mounted on vibration isolation springs with seismic lateral restraints
- 6.2 Wall-mounted Units
 - 6.2.1 Securely mounted
- 6.3 Ducts
 - 6.3.1 Laterally braced
 - 6.3.2 Able to accommodate movement at locations where they cross separation joints
- 6.4 Diffusers
 - 6.4.1 Grills anchored to the ducts or to the ceiling grid or to the wall
 - 6.4.2 Hanging diffusers adequately supported
- 7 Non-structural Walls and Partitions**
- 7.1 Concrete Block, Brick, Clay Block
 - 7.1.1 Reinforced vertically and/or horizontally
 - 7.1.2 Detailed to allow sliding at the top and movement at the sides
 - 7.1.3 Restrained at the top and the sides against falling
- 7.2 Stud-wall and other Lightweight Walls
 - 7.2.1 Partial-height partitions braced at their top edges
 - 7.2.2 If they support shelving or cabinets, securely attached to the structure of the building
- 8 Ceilings and Lights**
- 8.1 Ceilings
 - 8.1.1 Suspended ceilings with diagonal bracing wires
 - 8.1.2 Plaster ceilings with the wire mesh or wood lath securely attached to the structure above
- 8.2 Lighting
 - 8.2.1 Light fixtures (eg lay-in fluorescent fixtures) with supports independent of the ceiling grid
 - 8.2.2 Pendant fixtures with safety restraints (eg cables) to limit sway
 - 8.2.3 Emergency lights mounted to prevent them falling off shelf supports

9 Doors and Windows

9.1 Doors

- 9.1.1 If exit doors are heavy metal fire doors that might jam in an earthquake, provision of a crowbar or sledge hammer readily available to facilitate emergency opening
- 9.1.2 Automatic doors with manual overrides
- 9.1.3 Directions in which the doors swing

9.2 Windows

- 9.2.1 Glazing designed to accommodate lateral movement
- 9.2.2 Large windows, door transoms and skylights with safety glass

10 Appendages and Sundries

10.1 Parapets, Veneer and Decoration

- 10.1.1 Parapets reinforced and braced
- 10.1.2 Veneers and decorative elements with positive anchorage to the building

10.2 Fences and Garden Walls

- 10.2.1 Designed to resist lateral forces
- 10.2.2 Masonry walls reinforced vertically and rigidly fixed to their bases

10.3 Signs and Sculptures

- 10.3.1 Signs adequately anchored
- 10.3.2 Heavy and/or tall sculptures anchored to prevent overturning

10.4 Clay and Concrete Roof Tiles

- 10.4.1 Tiles secured to the roof with individual fixings for each tile

11 Movable Equipment

11.1 Communications

- 11.1.1 Radio equipment restrained from sliding off shelves
- 11.1.2 Telephones placed away from edges of desks and counters
- 11.1.3 Elevated loud speakers and CCTV anchored to the structure

11.2 Computers

- 11.2.1 Vital computer information backed up regularly and stored off site
- 11.2.2 Heavy computer equipment of significant height relative to width anchored or braced
- 11.2.3 Desktop items prevented from sliding off tables
- 11.2.4 Access floors braced diagonally or with seismically-certified pedestals

11.3 Storage of Records and Supplies

- 11.3.1 Shelving units anchored to walls
- 11.3.2 Shelves fitted with edge restraints or cords to prevent items from falling
- 11.3.3 Heavier items located on the lower shelves
- 11.3.4 Filing cabinet drawers latched securely

- 11.3.5 Heavily-loaded racks braced in both directions
- 11.3.6 Fragile or valuable items restrained from tipping over
- 11.3.7 Chemical supplies secured or stored in “egg crate” containers

- 11.4 Hazardous Items
 - 11.4.1 Gas cylinders tightly secured with chains at top and bottom (or otherwise) and with chains anchored to walls
 - 11.4.2 Chemicals stored in accordance with manufacturers recommendations
 - 11.4.3 Cabinets for hazardous materials given special attention with respect to anchoring

- 11.5 Furniture
 - 11.5.1 Heavy potted plants restrained from falling or located away from beds
 - 11.5.2 Beds and tables and equipment with wheels provided with locks or other restraints to prevent them rolling unintentionally

APPENDIX A-IX

HURRICANES

CHECK LIST FOR NON-STRUCTURAL COMPONENTS FOR HURRICANES

This Appendix constitutes a list of items and issues to be considered in designing the non-structural components of healthcare facilities to counteract the effects of hurricanes. Check lists are valuable as *aides-mémoire* for the exercise. For any particular project all of the items may not be relevant, but excluding items from a comprehensive list is always easier than adding relevant items to a short list.

1 Roofs

1.1 Light-weight Coverings

- 1.1.1 Gauge of corrugated sheeting
- 1.1.2 Type and quality of corrugated sheeting
- 1.1.3 Valley fasteners for trapezoidal profiles
- 1.1.4 Ridge fasteners supplemented by spacer blocks under the ridges or by hurricane washers
- 1.1.5 Fastener spacings specified for interior areas and for perimeter areas (for approximately 15% of the roof dimension along eaves, gables and ridges)
- 1.1.6 Asphalt shingles (vulnerable in high winds) laid on waterproofing felt on top of plywood sheets which in turn are fastened by screws or annular nails to supporting timber rafters
- 1.1.7 Wooden shingles individually fixed to close boarding which in turn is fastened by screws or annular nails to supporting timber rafters

- NB i In all cases the methods of fixing must, at least, comply with the manufacturers' recommendations for specified hurricane locations
- ii If battens are used, the fastening of the battens to the close boarding must be at least as strong as the fastening of the covering to the battens

1.2 Other coverings

- 1.2.1 Slates individually fixed to close boarding
- 1.2.2 Concrete or clay tiles individually fixed to close boarding

- NB i In all cases the methods of fixing must, at least, comply with the manufacturers' recommendations for specified hurricane locations
- ii If battens are used, the fastening of the battens to the close boarding must be at least as strong as the fastening of the covering to the battens

2 Windows

- 2.1 Made of laminated glass fixed to frames with structural silicon and able to resist,

without breaching, the impact of flying objects such as an 8-foot long 2-inch by 4-inch piece of timber moving at 35 miles per hour (similar to the requirements of Dade, Broward and Palm Beach Counties of Florida)

or

- 2.2 Protected by pre-installed or pre-fabricated shutters which are able to resist without breaching the impact of flying objects such as an 8-foot long 2-inch by 4-inch piece of timber moving at 35 miles per hour

or

- 2.3 Made of timber or aluminium louvres with provisions for excluding the rain during storm conditions and which are able to resist without breaching the impact of flying objects such as an 8-foot long 2-inch by 4-inch piece of timber moving at 35 miles per hour

NB The windows or shutters must be secured to the walls, slabs, beams or columns near all corners of each panel or in accordance with the manufacturers' recommendations for specified hurricane locations.

3 External Doors

3.1 Glass Sliding Doors

- 3.1.1 Made of laminated glass fixed to frames with structural silicon and able to resist without breaching the impact of flying objects such as an 8-foot long 2-inch by 4-inch piece of timber moving at 35 miles per hour

or

- 3.1.2 Protected by pre-installed or pre-fabricated shutters which are able to resist without breaching the impact of flying objects such as an 8-foot long 2-inch by 4-inch piece of timber moving at 35 miles per hour
- 3.1.3 Moving frames with a certificate from the supplier indicating compliance with the requirements for the appropriate intensity of hurricanes, including both strength and deflexions
- 3.1.4 Fixed perimeter frames secured to the walls, slabs, beams or columns by bolting or in accordance with the manufacturers' recommendations for specified hurricane locations
- 3.1.5 Tracks of the top and bottom rails deep enough to prevent the moving doors from being dislodged in specified hurricanes

3.2 Roller Shutter (or Overhead) Doors

- 3.2.1 Certificates from the suppliers indicating compliance with the requirements for the appropriate level of hurricanes, including both strength and deflexions
- 3.2.2 Fixed perimeter frames secured to the walls, slabs, beams or columns by bolting or in accordance with the manufacturers' recommendations for specified hurricane locations

- 3.2.3 Side tracks deep enough to prevent the moving doors from being dislodged in specified hurricanes unless some other mechanism is employed to prevent such an occurrence
- 3.3 Other Doors
 - 3.3.1 Timber doors with solid cores or made up from solid timber members and able to resist without breaching the impact of flying objects such as an 8-foot long 2-inch by 4-inch piece of timber moving at 35 miles per hour
 - 3.3.2 Each door leaf fixed by hinges or bolts in at least four locations adjacent to all corners
- 4 Other Apertures
 - 4.1 Protection from wind and rain provided by pre-installed or pre-fabricated shutters which are able to resist without breaching the impact of flying objects such as an 8-foot long 2-inch by 4-inch piece of timber moving at 35 miles per hour
 - 4.2 Shutters secured to the walls, slabs, beams or columns near all corners of each panel or in accordance with the manufacturers' recommendations for specified hurricane locations
- 5 Solar Water Heaters and Air-conditioners
 - 5.1 Certificates from the suppliers indicating compliance with the requirements for the appropriate intensity of hurricanes for both manufacture and installation

APPENDIX A-X

RATIONAL APPROACH TO DETERMINING PRIORITIES FOR RETROFITTING HEALTHCARE BUILDINGS

1 Introduction

Does your disaster preparedness plan assume the full utilisation of existing hospitals? What would happen if fire engines cannot exit from their garages? How essential are internal and external telecommunications? Does your plan require the post-disaster functioning of power plants, water supply systems and sewage treatment plants?

In any community many or most of the existing buildings are at risk in a natural hazard event. Remedial action by government agencies for structures they are responsible for would considerably mitigate future losses. Vital facilities necessary for providing immediate post-disaster relief such as hospitals, emergency communications centres, schools and public utilities should be given high priority.

Natural hazard damage mitigation for new construction is relatively easily achieved for new buildings through the use of up-to-date standards and specifications. However, many existing buildings do not incorporate damage mitigation provisions. Where such buildings are regarded as post-disaster assets their suitability for their tasks have a direct bearing on the effectiveness of any disaster preparedness plan.

It is recognized that a programme to bring about the correction of deficiencies in all essential facilities within (say) a 5-year plan is neither physically nor economically feasible. Such a programme is best carried out in accordance with a rational process over a period of the order of one generation (say 25 years). The plan which follows deals with the first 5 years of the overall programme.

Figure Ap6 - Gantt Chart for 5-year Plan

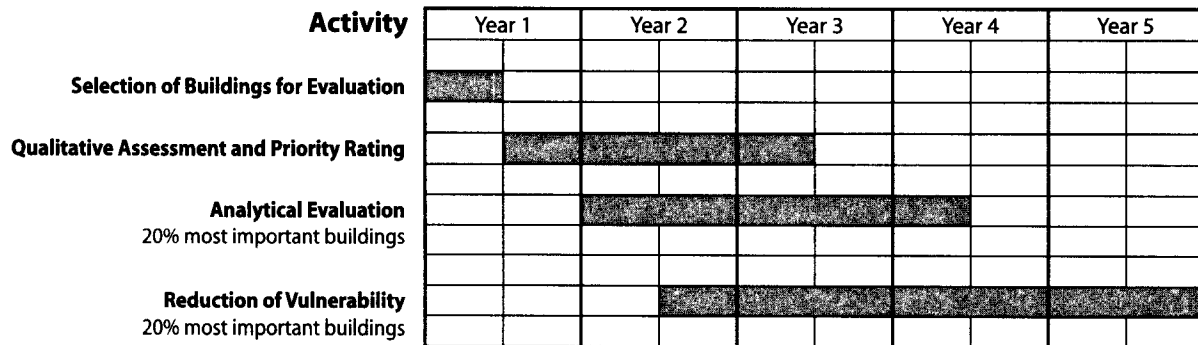

2 Outline of the Plan

The programme of damage abatement for buildings required for post-disaster relief purposes after hurricanes, earthquakes and floods could include the following steps:

- 1 List those buildings and facilities which are important.
- 2 Carry out qualitative assessments of the facilities listed in 1. This would establish which facilities are obviously satisfactory and those which are obviously not satisfactory.
- 3 Carry out analytical evaluations of all the other (*ie* doubtful) facilities listed in 1.
- 4 Embark on a programme of reduction or removal of vulnerable aspects where these are shown to exist. Such a programme would follow a priority listing of facilities requiring improvement.

It is suggested that the work to be accomplished in the first 5 years includes all of items 1 and 2, and items 3 and 4 only for 20% of the most important buildings and facilities.

3 Selection of Healthcare Buildings for Evaluation

It is suggested that the ministry of health produce the first list of buildings based on use and occupancy (number of occupants). Such a list could have the following classifications:

- Class A Facilities which must remain operational during and after a disaster
- Class B Other essential facilities
- Class C All other facilities

Other approaches to selection may involve considerations such as balanced risk of damage, cost-effective level of abatement and remaining life expectancy of facilities. Such approaches would need (*inter alia*) the results of the qualitative and analytic evaluations. However it would be useful to discuss these “economic” considerations here.

3.1 Benefit-Cost Studies

Benefit-cost studies can be usefully employed in assisting in developing and implementing a damage reduction programme. It is not feasible economically to eliminate all of the ill effects of natural hazards. Hence it is necessary to decide how much of the country's resources should be devoted to mitigating the potential adverse effects of natural hazards and to choose the most effective methods.

Benefit-cost studies by themselves do not make decisions. They are a tool for analysing a wide range of facts and assumptions and for demonstrating the implications of alternative strategies. The usefulness of such studies is closely related to the validity and completeness of the data and assumptions. It would be useful however to start with simple (and possibly crude) measures of the vulnerability of buildings to test the procedures and to develop confidence in the tool. The government could initiate studies and programmes to develop and collect data concerning the many less immediate and often intangible costs of disasters *eg* loss of productivity, loss of tax base and the psychological and economic impacts on the community.

4 Technical Selection

The above methods of selection of buildings for analysis are based largely on non-engineering criteria - use, occupancy, economics. Ignoring the above, there can be a purely engineering or technical approach to the selection of buildings for evaluation. This is demonstrated by Flow Chart 1 (*following*).

In the chart "seismicity index" refers to the level of seismic risk in the area as defined by the document ATC-3²⁴, "seismic performance categories" takes into account the importance of the facility (see ATC-3) and "OP" is the occupancy potential of the building.

4.1 Qualitative Assessments

This level of assessment does not envisage exhaustive testing of materials in place nor sophisticated computation of stresses. It does involve a careful review of all readily available data such as drawings, an inspection of the building without destructive testing and a non-mathematical assessment of the data. By its very nature this qualitative assessment requires the exponent to have a greater degree of knowledge about the effects of natural hazards on facilities and a greater maturity of engineering judgement than any of the other functions in this programme.

Flow Chart 2, (*following*), sets out an appropriate methodical approach to qualitative assessment. In this chart t_x is the length of time in years permitted for the abatement of potential vulnerability of the facility. The term α_t is a factor determined by policy makers (in this case government) but is likely to be in the range of 20 to 35. (A typical value for a North American community would be 12). It is a measure of the number of years within which a community wishes to put its house in order. The term r_c is the ratio of the existing "strength" of the facility to the desired "strength".

4.2 Priority Rating

Many factors will come into play for this aspect of the programme and most of these factors will not be of a strictly technical nature. However it would greatly assist the exercise if certain objective and technical procedures were introduced as tools.

Such a tool is the determination in a uniform manner of the length of time that should be allowed to bring each facility up to the desired level of safety. Then those facilities with the shortest times would have the highest priority.

Figure 6 (*following*), "Permissible Time for Vulnerability Reduction", illustrates the approach. "Capacity ratio" (r_c) was introduced in the previous section of this document. "Time to strengthen or abolish" (t_x) was also introduced in that section. For the purposes of this exercise, the graphs A, B and C can be taken as relating to the different classes of buildings described in the earlier section "Selection of Buildings for Evaluation". The λ values are leniency ratios. The smaller the ratio the

²⁴Tentative Provisions for the Development of Seismic Regulations for Buildings (ATC-3) - NSF/NBS, USA

less lenient the community can be in judging the facility. In Figure 1, the suggestion is that all class A buildings must be brought up to mark in 15 years, class B in 25 years and class C in 35 years. The actual figures to be used will of course depend on government policy.

4.3 Analytical Evaluation

Facilities whose performances are deemed to be doubtful, when assessed qualitatively, will be subjected to an analytic evaluation. Since this is a time-consuming and therefore expensive exercise it would be appropriate to carry it out only when the funds were available for implementing the possible action indicated by this evaluation.

The procedure is illustrated diagrammatically by Flow Chart 3 (*following*). All the terms in that chart have been previously described.

In the suggested 5-year Plan only 20% of the critical facilities (post-disaster assets) will be subjected to this evaluation.

5 Reduction or Removal of Hazards

This is the physical implementation phase of the programme. In the proposed 5-year Plan work would be limited to 20% of the post-disaster assets.

This phase of the programme follows the normal construction project route of preparation of tender and construction documents, procurement of a contractor and implementation of the works on site. In this case the works would consist of retrofitting of the existing facilities.

6 Pilot Programmes

In a sense the 5-year Plan described above constitutes a pilot programme, especially in respect of items 3 and 4 of the Plan. However an even smaller pilot programme could be designed. Such a programme could have as its aim the seeking of funding for the larger exercise.

7 References

Building Practices for Disaster Mitigation - US National Bureau of Standards
Evaluation of Earthquake Safety of Existing Buildings - B Bresler

Flow Chart 1 - Selection of Buildings for Evaluation

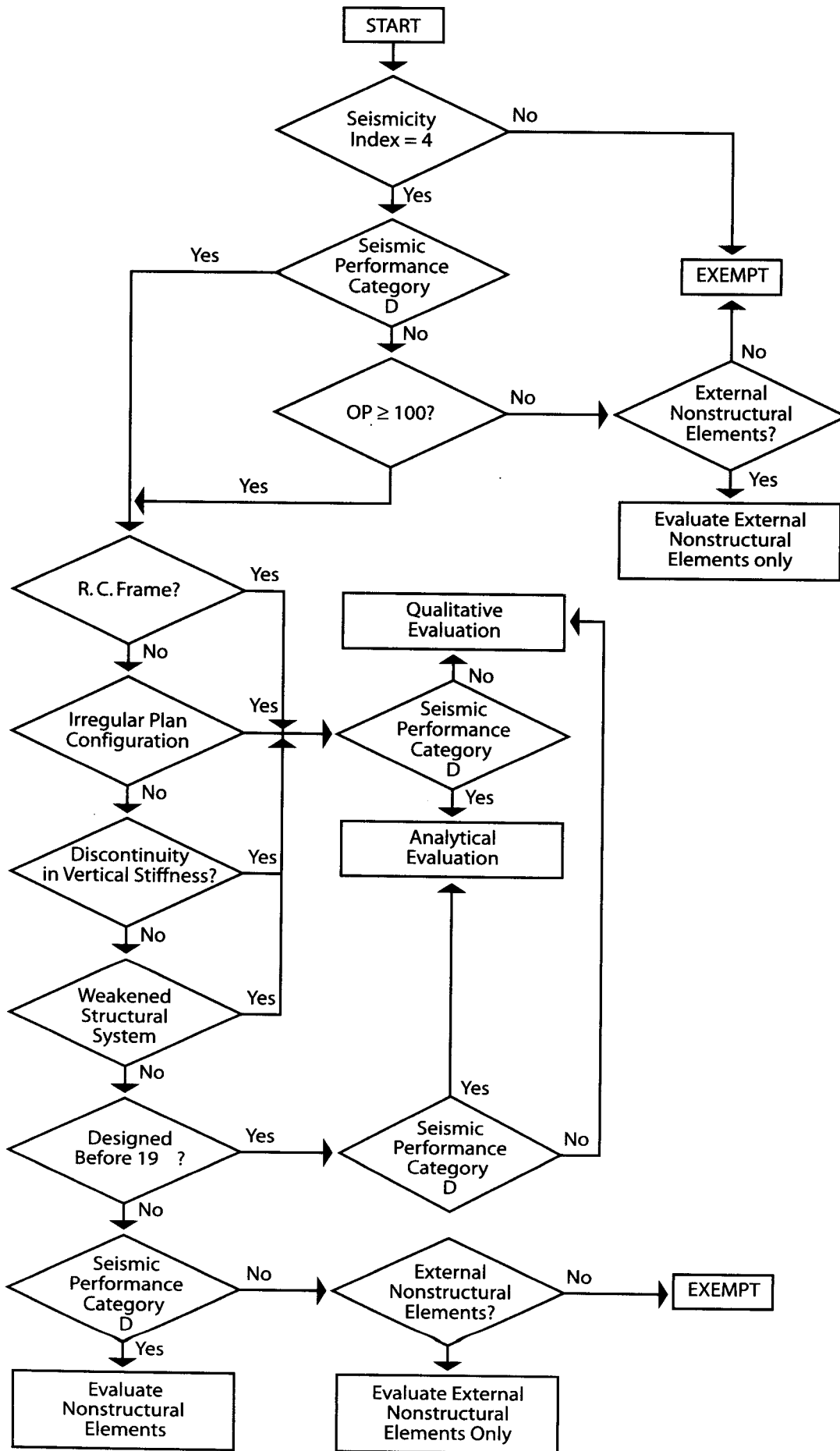

Flow Chart 2 - Qualitative Assessment

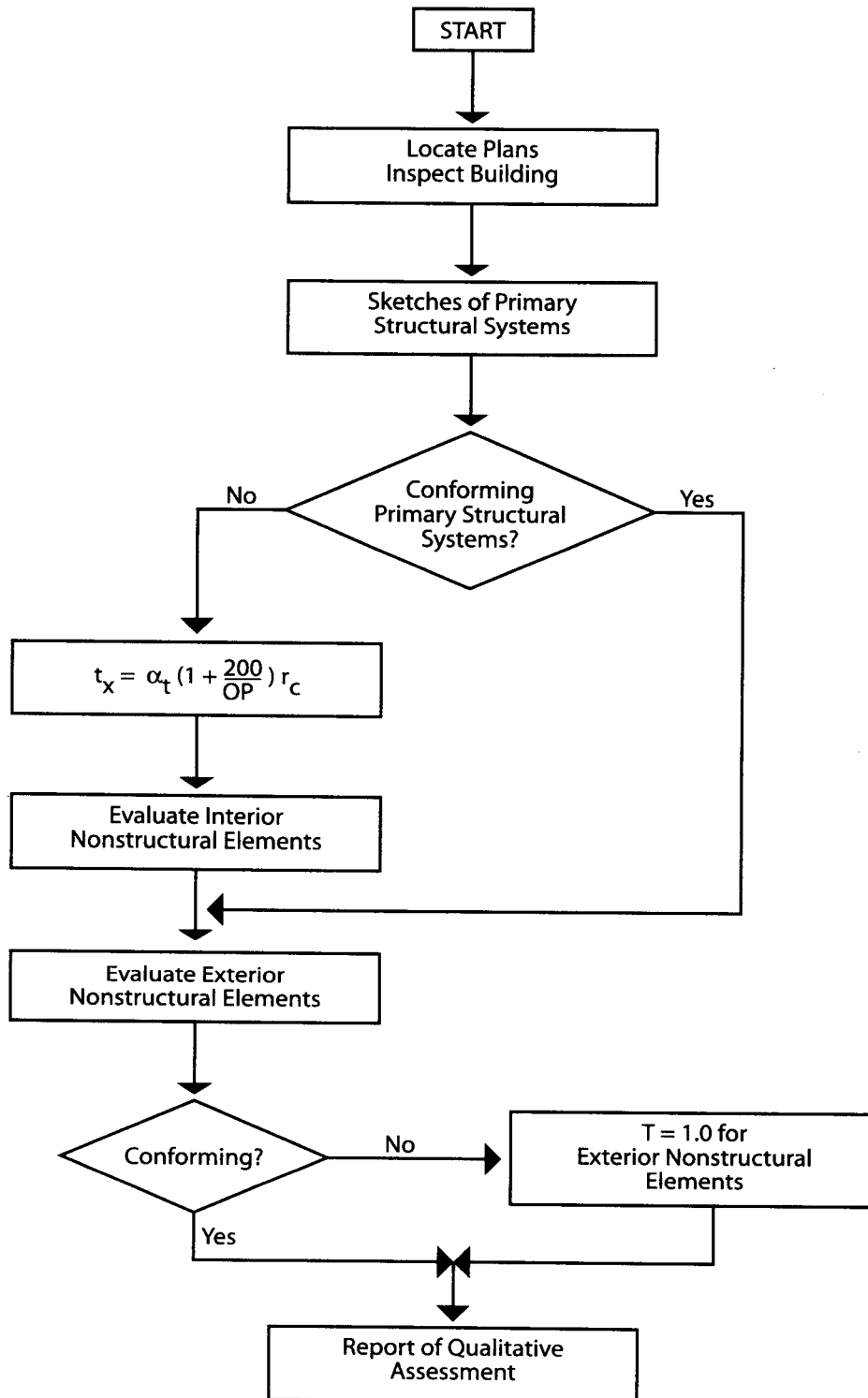
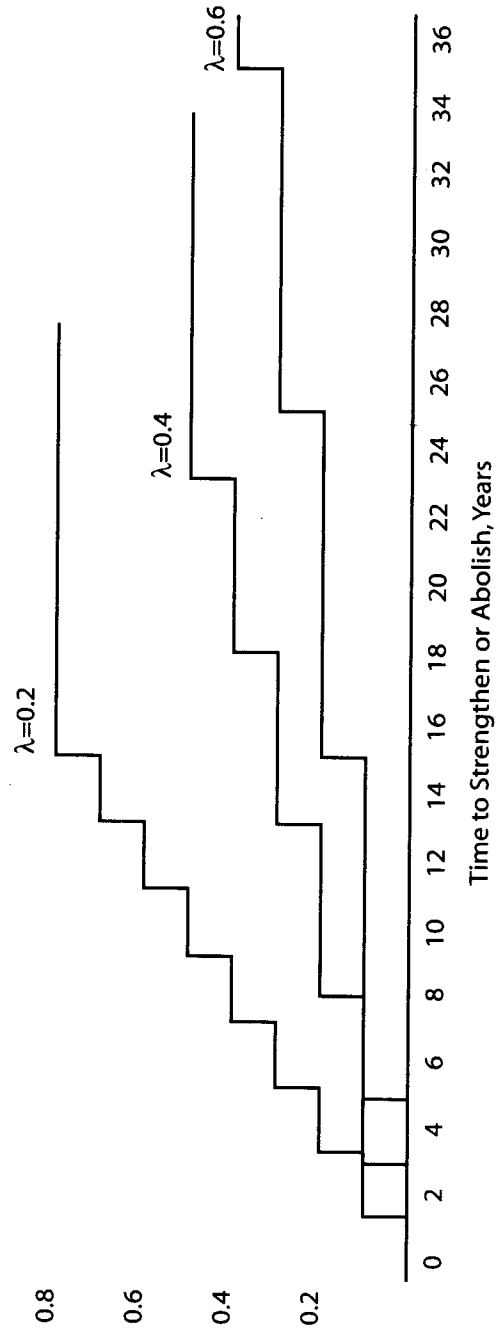
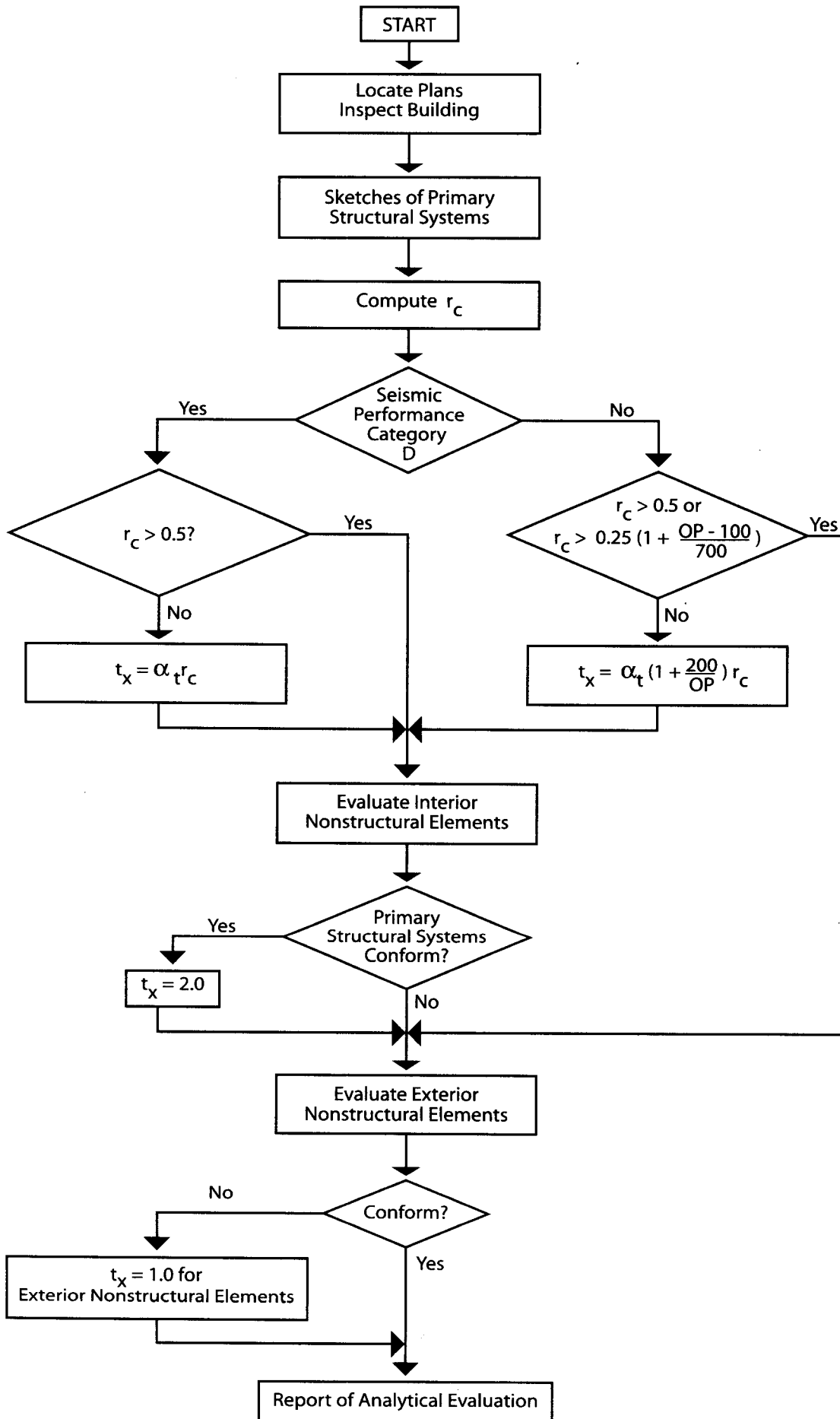

Figure AP7 - Permissible Time for Natural-hazard Damage Abatement



Flow Chart 3 - Analytical Evaluation



APPENDIX A-XI

MAINTENANCE AS A TOOL FOR MITIGATION

This Appendix is based on the work of Alwyn T Wason.

1 General

The physical condition of many Caribbean hospitals is poor. Most components show lack of maintenance and repair. It is considered that a major effort should be taken to bring the condition of the buildings to the standard where a normal maintenance crew can be expected to deal with the routine maintenance requirements of the facility. It is considered, also, that the existing staff and maintenance budget is generally insufficient to provide for proper maintenance.

It is normal that for public buildings with the heavy usage of a hospital, the annual maintenance budget should amount to about 4% of the contemporary capital cost of the building and equipment, assuming that the facilities are in good condition to start with. For hospitals, it is estimated that the replacement cost is about US\$130,000 per bed. (This figure includes for common and administrative areas as well as infrastructure.) The maintenance allocation should therefore be no less than US\$5,000 per bed per year.

The maintenance of a hospital, rather than being a one-off activity as is the construction of the hospital, is a continuous daily operation of the institution and is an important ingredient in the delivery of healthcare.

A good maintenance system is also a good disaster mitigation system, as the review of damage caused by recent hurricanes and floods has shown. To some extent the damage to buildings was due to lack of sustained maintenance of critical items. Also, a well-operated system of maintenance for buildings and equipment has the effect of being a very effective disaster mitigation measure in terms of cost and facility usage. It ensures the most economic way to keep the building and equipment in the best of form for normal use, given the original design and materials. It is essential that a maintenance plan be included in disaster mitigation plans.

This Manual therefore stresses the need for continuous attention to all parts of the building and equipment from sweeping of the floors to care of the grounds.

This Manual does not deal with the maintenance needs of off-site electricity, telephone communications and off-site water supply as maintenance of these lifelines are carried out by the relevant utility organisations. On the other hand, standby electricity plant and water systems (storage tanks and pumps) must be maintained by the hospital-maintenance organisation.

2 Proposed Maintenance System

The purposes for maintaining a building and its associated plant are to ensure that the facility can:

- function at its designed level at all times;
- function for the normal life spans of the building and of the plant;
- resist the effects of extreme natural events such as hurricanes, floods, and earthquakes without damage to its occupants and with minimal repair or rehabilitation necessary after the passing of the event (provided that the original design and construction were satisfactory for this purpose).

All maintenance activities should be systematised and pro-active and not merely reactive. It is important to recognise that maintenance is not necessarily repair. Too often repair is considered to be the main purpose of the maintenance system rather than the prevention of the need for repair. The scheduled oiling of door hinges and window operators or the painting of exterior wooden members is necessary to prevent failure of the equipment or rotting of the wooden members.

It is recommended therefore that comprehensive maintenance systems be instituted by health ministries. These systems should comprise:

- an organisational structure with clearly defined duties and responsibilities;
- an operation maintenance manual and procedures reference for the buildings and equipment;
- a management information system which will produce reports on budget, stocks, inventories of equipment, staffing requirements, etc;
- a preventative maintenance plan for equipment;
- a building maintenance plan - including roofs, walls, electricity, water lines;
- a continuous maintenance training plan for selected maintenance personnel.

3 Planning of Maintenance Activities

The planning of the maintenance activities will normally be carried out by the hospital superintendent but this planning, which should include the development of a detailed annual maintenance budget, can only be effective if there is a detailed list of areas, spaces, materials and equipment to be maintained and a list of defects to be corrected. The maintenance staff must therefore be trained to examine all parts of the buildings and plant in their care and to record deficiencies. Such lists must be prepared on an annual basis, but this does not preclude the immediate attention to problems which are endemic in many hospitals.

It must be emphasised that a careful record of all maintenance activities is essential, and every effort must be taken to avoid returning to the situation where *ad hoc* repair is the norm. The check list given in this Manual is a guide for the detailed examination of all parts of the facility and should be reviewed by the hospital superintendent and hospital administrator to ensure that maintenance is indeed being carried out efficiently.

Reporting of work done is also an essential part of the maintenance system. A simple reporting form is included in this Manual but the hospital superintendent may

wish to devise his own form which may be more responsive to the problems in the particular hospital. It is considered, however, that the simpler the form the better will be the chances of having the form properly filled out and submitted monthly.

4 Maintenance as a Part of Disaster Mitigation

If a good system for maintenance is not properly organised, funded, staffed and carried out, then all other disaster mitigation methods could prove insufficient. Experience indicates that roofs, walls, and equipment in general are more vulnerable to failure if normally operated at near breakdown or at any level of technical deficiency.

While a properly designed and maintained building would be resistant to natural hazards yet experience shows that some additional precautions may have to be taken to secure the hospital and allow it to function during and immediately after such events. The principal areas to be examined for maintaining hurricane resistance (in particular) of the hospital and the corrective measures to be taken are:

4.1 Roofs

- All corroded roof sheets should be replaced.
- Examine the purlins and rafters and replace the rotten ones. Make sure that the drive screws are driven into solid material and cannot be pulled out easily.
- Make sure that the ridge cap is solidly fixed to the roof sheet and that the wind cannot peel the ridge cap off.
- Check the wall plate to be sure that it is not rotten. If so, replace it and secure the plate to the wall by bolts.

4.2 Doors and Windows

- Examine the doors and windows. They must close tightly.
- Ensure that the operators on louvred windows are all working.
- Replace all broken glass in windows.

4.3 External Areas

Flooding often follows a hurricane. Check to see how high the water reached in previous heavy rain storms and ensure that drains are cleared to carry the rain water away from the building and that no storm water can get into the building.

5 Proposed Maintenance Organisation and Staffing

Basic assumptions:

- The hospital administrator is responsible to the ministry for the efficient operation of the hospital (including the general staff matters, buildings, equipment and grounds) and for the expenditures authorized in the annual estimates.
- The hospital superintendent is responsible for the maintenance of all buildings and plant and for providing advice to the hospital administrator on capital requirements and on the condition of the buildings and plant.

- Technical staff (as required) report to the hospital superintendent including:
 - carpenters
 - plumbers
 - electricians
 - painters
- The gardeners and cleaning staff report to the hospital administrator.
- Major repair or renovation projects must be specifically authorized by the hospital superintendent and the hospital administrator depending on the budget requirements, but normal maintenance and minor repair can be carried out by in-house staff without specific authorization.

The following comments are appropriate at this point:

- Annual inspections of the buildings and plant must be carried out. (The recommended time for such inspections is August so the annual estimates can be prepared.)
- Inspections of the windows, doors, roofs and drainage ditches must be carried out in April and repairs effected before the hurricane season.
- The budget estimates for effective maintenance must be based on detailed examination of the buildings and plant supplemented by reports from the users of the buildings and plant - patients, nurses, doctors, administrators and other staff.
- The hospital superintendent must make monthly reports to the hospital administrator detailing the work carried out, the cost of the work, the staff available and the problems to be dealt with during the financial year and those requiring further examination and/or funding.

It is expected that major renovation work which may be necessary will be contracted out and not carried out by the regular maintenance staff.

6 Checklists and Frequencies for Maintenance Operations

Three tables are presented covering:

- the building interior;
- the building exterior;
- the compound.

The following abbreviations are used in the tables:

Frequency	Operator
I: Immediately	C: General cleaners
D: Daily	MS: Maintenance staff
W: Weekly	SS: Hospital Superintendent
Q: Quarterly	SA: Hospital Administrator
A: Annual	G: Gardener

- Notes: 1 For **frequency** the maximum period is given.
2 For **operator** the person named is the one responsible for seeing that the operation is carried out.

6.1 Building Interior

Spaces	Frequency	Operator
<p>Washrooms and Toilet</p> <p>Inspect and report deficiencies Wash floors, toilet bowls, urinals, wash basins with disinfectant and deodorant Order replacements Replace broken elements Repair Paint</p>	<p>D D I Q I A</p>	<p>C/MS C SS/SA MS SS MS</p>
<p>Corridors and Wards</p> <p>Inspect and report deficiencies Wash walls</p>	<p>D W</p>	<p>C C</p>
<p>Ceilings, Interior Roofs, Canopies</p> <p>Inspect and report deficiencies Repaint</p>	<p>A every 4 years</p>	<p>MS MS</p>
<p>Laboratories and other Technical Areas</p> <p>Clean all counters, floors and walls</p>	<p>D</p>	<p>MS</p>
<p>Plumbing</p> <p>Inspect and report deficiencies Repair or replace defective pieces</p>	<p>D I</p>	<p>MS SS</p>
<p>Internal Communication System</p> <p>Inspect all internal communications to ensure that the system is functioning properly and report defects.</p>	<p>Q</p>	<p>SS</p>
<p>Electricity</p> <p>Inspect electricity wiring on a room by room basis and report deficiencies.</p>	<p>Q</p>	<p>MS</p>
<p>Furniture</p> <p>Repair or replace broken elements</p>	<p>A</p>	<p>MS</p>

6.2 Building Exterior

Spaces/Materials	Frequency	Operator
<p>Wood</p> <p>Inspect panels, louvres, railings and report deficiencies</p> <p>Replace all broken wood louvres</p> <p>Replace other damaged elements</p> <p>Clean and paint marked surfaces</p>	<p>A</p> <p>D</p> <p>Q</p> <p>A</p>	<p>MS</p> <p>SS</p> <p>SS</p> <p>MS</p>
<p>Windows</p> <p>Inspect and report deficiencies</p> <p>Remove broken glass louvres or panes (see above also)</p> <p>Order replacements for broken glass and other elements</p> <p>Replace broken elements</p> <p>Grease and oil louvre operators or handles</p> <p>Replace broken wire-mesh grills</p> <p>Wash windows</p>	<p>D</p> <p>I</p> <p>I</p> <p>Q</p> <p>A</p> <p>Q</p> <p>Q</p>	<p>MS</p> <p>MS</p> <p>SS</p> <p>MS</p> <p>MS</p> <p>SS/MS</p> <p>C/MS</p>
<p>Doors and Frames and Partitions</p> <p>Inspect and report deficiencies</p> <p>Oil hinges etc.</p> <p>Replace defective and broken hardware</p> <p>Repair or replace defective doors and/or frames</p>	<p>Q</p> <p>A</p> <p>I</p> <p>I</p>	<p>MS</p> <p>MS</p> <p>SS</p> <p>SS</p>
<p>Stairs and Balconies</p> <p>Sweep stairs and balconies</p> <p>Wash stairs, walls and rails</p> <p>Clean metal work of rust and coat with primer and paint</p> <p>Sand and paint wood railings or posts</p>	<p>D</p> <p>Q</p> <p>A</p> <p>every 2 years</p>	<p>C</p> <p>C</p> <p>MS</p> <p>MS</p>
<p>Roofs and Gutters</p> <p>Inspect and report deficiencies</p> <p>Repair and replace roof sheets and gutters as required</p>	<p>A</p> <p>W</p>	<p>MS</p> <p>SS</p>
<p>Metal Panels</p> <p>Inspect</p> <p>Wash and remove graffiti</p> <p>Clean rust and repaint</p>	<p>A</p> <p>A</p> <p>every 2 years</p>	<p>MS</p> <p>MS</p> <p>MS</p>

6.3 Compound

Spaces/Materials	Frequency	Operator
Gardening		
Clean flower beds	W	G
Watering and fertilise plants	D	G
Remake plant beds	Q	G
Prune plants, trim hedges	M	G
Grass playing fields	As required	G
Cut grass	W	G
Fence		
Inspect and report deficiencies	Q	MS
Repair	Q	MS
Paint	every 2 years	MS
Walkways and Courtyards		
Sweep	D	C
Clear litter and rubbish	D	C
Drainage Ditches		
Clean routinely	W	C
Clear blockages caused by excessive rain	I	MS
Repair damaged drains	A (in August)	MS
Water Mains		
Inspect and report deficiencies	Q	MS
Maintain earth cover	Q	MS
Repair breaches/leaks	I	SS
Septic Tank		
Inspect and report deficiencies	A (In August)	MS
Clean and flush out	Every 4 years	MS
Repair	I	SS
Erosion near Structures		
Inspect and report deficiencies after heavy rainfall	Q and as required	MS
Return soil, grass area, re-direct water source	Q and as required	MS
Repair eroded area	I	SS

6.3 Compound (cont'd)

Rubbish bins		
Empty drums and burn (or carry away) rubbish Inspect and replace bins if necessary	D A	C MS

7 Proposed Monthly Report Form

To: Hospital Administrator

Report of the Maintenance Division

For the month of:

Submitted by:

Date:

Trade	Area or Class	Work done	Material Cost	Labour Cost	Remarks
Carpentry Doors Windows Roof Floors					
Masonry					
Electricity					
Plumbing					
Painting					
Other trades					

8 Guidelines for Maintenance Checklists

In reporting deficiencies, the maintenance staff or handyman should be guided by the following *aides-memoire*. It should be noted that the guides which are given here are not intended to be exhaustive. They will, however, focus inspection on the critical areas.

Spaces/Materials	Good	Bad
<p>(a) Washrooms and Toilets</p> <ul style="list-style-type: none"> • Check to see if the walls are cracked • Where the walls are made of rubble stone see if the mortar is in good condition • Check to see if items such as soap holders and toilet paper holders are in place and are in working order 	<p>.....</p> <p>.....</p> <p>.....</p>	<p>.....</p> <p>.....</p> <p>.....</p>
<p>(b) Corridors and Wards</p> <ul style="list-style-type: none"> • Examine the floors to see if the concrete has been damaged in any way so that persons walking in the corridors or wards may trip • Check to see if the walls are damaged and need repairing 	<p>.....</p> <p>.....</p>	<p>.....</p> <p>.....</p>
<p>(c) Ceilings, Interior Roofs, and Canopies</p> <ul style="list-style-type: none"> • See if the ceilings and the undersides of the roofs and canopies have any watermarks which indicate leaks in the roof • See if any timber supports are rotten • Where the roof supports are of steel, check to see if there is any rust • See if any ceiling tiles need replacing 	<p>.....</p> <p>.....</p> <p>.....</p> <p>.....</p>	<p>.....</p> <p>.....</p> <p>.....</p> <p>.....</p>

Spaces/Materials	Good	Bad
<p>(d) Plumbing</p> <ul style="list-style-type: none"> • Check to see if there is any water on the floor • If there is, examine the wash basin to see if it is plugged • Examine the WC to see if the bowl is cracked • See if the flush tank is cracked • Check to see if the toilet seat cover is broken • See if the flush handle or pull chain is broken • See if the toilet bowl is fixed properly to the floor so that it does not rock when being used • See if the sewer pipe is properly fixed to the toilet and that there is no leaking at the joint 	<p>.....</p> <p>.....</p> <p>.....</p> <p>.....</p> <p>.....</p> <p>.....</p> <p>.....</p> <p>.....</p>	<p>.....</p> <p>.....</p> <p>.....</p> <p>.....</p> <p>.....</p> <p>.....</p> <p>.....</p> <p>.....</p>
<p>(e) Electricity</p> <ul style="list-style-type: none"> • See if all light bulbs are working and that all are in place • See if the wall plates are in good condition • See if the wall switches or pull switches are working • See if wall outlets are working 	<p>.....</p> <p>.....</p> <p>.....</p> <p>.....</p>	<p>.....</p> <p>.....</p> <p>.....</p> <p>.....</p>
<p>(f) Windows</p> <ul style="list-style-type: none"> • See if the windows can close securely • See if the window operators are in good condition and are working • See if the bolts and locks are in working condition • See if the timber surrounding the windows is rotten and should be replaced • See if the windows leak even when closed 	<p>.....</p> <p>.....</p> <p>.....</p> <p>.....</p> <p>.....</p>	<p>.....</p> <p>.....</p> <p>.....</p> <p>.....</p> <p>.....</p>

Spaces/Materials	Good	Bad
<p>(g) Doors and Frames and Partitions</p> <ul style="list-style-type: none"> • See if the doors can close properly • See if the bolts and locks are in place and are working • See if the door frame is in good condition and that the timber is not rotten • Where the door is a wood door (brace and batten) see that the door has not warped • Check the partitions to see if the walls are in good condition • Report any loose mortar in a rubble wall • Report any cracked wall 	<p>.....</p> <p>.....</p> <p>.....</p> <p>.....</p> <p>.....</p> <p>.....</p> <p>.....</p>	<p>.....</p> <p>.....</p> <p>.....</p> <p>.....</p> <p>.....</p> <p>.....</p> <p>.....</p>
<p>(h) Roof and Gutters</p> <ul style="list-style-type: none"> • Check roofs for leaks • Check gutters for holes • Check gutter brackets to see if they are broken or rusted 	<p>.....</p> <p>.....</p> <p>.....</p>	<p>.....</p> <p>.....</p> <p>.....</p>
<p>(i) Fence</p> <ul style="list-style-type: none"> • With a chain link fence, check to see if the fence is broken • See if the fence posts are firmly in the ground • With a timber fence, check for rotten timber 	<p>.....</p> <p>.....</p> <p>.....</p>	<p>.....</p> <p>.....</p> <p>.....</p>
<p>(j) Water mains</p> <ul style="list-style-type: none"> • Check ground to see if there are any wet spots which would indicate a leaking water main • See if the water main is properly buried beneath the ground, or is well protected by concrete 	<p>.....</p> <p>.....</p>	<p>.....</p> <p>.....</p>

Spaces/Materials	Good	Bad
<p>(k) Septic tank</p> <ul style="list-style-type: none"> • Check to see if the tank has been cleaned in the last three years • See if the access covers fit properly, are in good condition and can be removed for cleaning • If the access covers can be opened too easily, members of the public may remove the covers wilfully • See if the holders for the covers will cause people to trip. The holder should be recessed with just enough room for a pickaxe blade to get under the holder. • See if the inlet pipe is firmly fixed to the tank and that there is no leak • Where there is a soak-away check to see if the pipe to the soak-away is firmly bedded • See if there is any odour around the tank. If there is, the tank needs cleaning or another soak-away should be dug • Where there are tile fields, check to see if the pipes (tiles) are exposed. They should be well below ground level • See if the tiles are working and that there is no water on the ground around the pipes 	<p>.....</p> <p>.....</p> <p>.....</p> <p>.....</p> <p>.....</p> <p>.....</p> <p>.....</p> <p>.....</p> <p>.....</p>	<p>.....</p> <p>.....</p> <p>.....</p> <p>.....</p> <p>.....</p> <p>.....</p> <p>.....</p> <p>.....</p> <p>.....</p>
<p>(l) Erosion near Structures</p> <ul style="list-style-type: none"> • Examine the ground around the buildings to see if the rain water has removed any material - soil or stones • Check around the pipes to see if the pipes that were buried are still properly buried • Check around telephone or electricity poles on the property to see whether the rain water has removed soils around the bottom of the poles 	<p>.....</p> <p>.....</p> <p>.....</p>	<p>.....</p> <p>.....</p> <p>.....</p>

APPENDIX A-XII

RESOURCE CENTRES AND BACKGROUND READING

1 Resource Centres

There is much assistance available to healthcare “owners” and custodians who desire facilities which would perform well during, and immediately after, natural hazard events. Some agencies equipped to provide such assistance are listed below:

- Pan American Health Organisation (PAHO) - Emergency Preparedness & Disaster Relief Coordination Programme (PED)
- Caribbean Disaster Emergency Response Agency (CDERA)
- The Organisation of American States (OAS)
- The University of the West Indies (UWI) and its Seismic Research Unit (SRU)
- The Caribbean Institute for Meteorology and Hydrology (CIMH)
- The University of Technology (UTEC), the University of Guyana (UG), Instituto Tecnológico de Santo Domingo (INTEC) and others
- Council of Caribbean Engineering Organisations (CCEO) and its constituent member bodies
- Association of Commonwealth Societies of Architects in the Caribbean (ACSAC) and its constituent member bodies
- Consulting firms specialising in natural hazards
- Individual specialists in the relevant fields
- Statutory bodies and government agencies

2 Background Reading

- Disaster Mitigation Guidelines for Hospitals and Other Health Care Facilities in the Caribbean, PAHO(CPC), 1992
- Disaster Mitigation for Health Facilities - Guidelines for Vulnerability Appraisal and Reduction in the Caribbean, PAHO(CPC)/ECHO, 2000
- Principles of Disaster Mitigation in Health Facilities, PAHO(Washington), 2000
- Disaster Mitigation in Health Facilities – CD-ROM containing training material for the earthquake hazard published by PAHO(Washington) in 2001
- Seminar on the Design of Health Facilities to Resist Natural Hazards, Barbados, September/October 2002 – CD-ROM of agenda, presentations, papers, participants list, conclusions, reference bibliography, pictures and other related material – published by PAHO(CPC)/ECHO/CIDA
- Strengthening Building Codes for Health Facilities in the Caribbean a CD-ROM containing the reports of several vulnerability studies of hospitals undertaken by PAHO(CPC)/ECHO over the past ten years. Published in 2003
- “Winds of Change” Seminar on Mitigation for Natural Hazards, Barbados, April 2003 – CD-ROM of agenda, presentations, papers, participants list, conclusions, reference bibliography, pictures and other related material – published by PAHO(CPC)/ECHO
- Disaster Mitigation in Health Facilities – CD-ROM containing training material for the hurricane hazard published by PAHO(CPC) in 2003



Pan American Health Organization
Pan American Sanitary Bureau, Regional Office of the
World Health Organization
Office of Caribbean Programme Coordination
P.O. Box 508, Bridgetown, Barbados
www.pahocpc.org